

KLS[®]

ACCESSORIES

POWERED BY
KELLYS
BIKE COMPANY

17

EVERY BIKE HAS A MISSION

ACCESSORIES CATALOGUE SEASON 2017





EVERY BIKE
HAS A MISSION





006 - 065

RIDER

CLOTHING, CASUAL CLOTHING, GLOVES,
SUNGLASSES, HELMETS, BACKPACKS

066 - 133

BICYCLE

LIGHTS, REFLECTIVE ACCESSORIES, CYCLE COMPUTERS,
BOTTLE AND BOTTLE CAGES, PUMPS, LOCKS, BAGS,
BASKETS, MUDGUARDS, KICKSTANDS, CHAINSTAY
PROTECTORS, BELLS, SADDLES, HANDLEBARS, STEMS,
SEAT POSTS, GRIPS, PEDALS

134 - 153

SERVICE AND CARE

TOOLS, CLEANERS, LUBRICANTS, BRAKE ACCESSORIES,
REPAIR KITS, TUBES, TIRES, CHAINS



**EVERY BIKE
HAS A MISSION**





RIDER

Proper outfit is irreplaceable in every cycling activity. Only professional, specially designed products allow you to enjoy wonderful activity that the cycling is. Bicycle outfit is also a matter of style. Ride like a pro and express yourself on the bike!





STYLE

While riding a bike the style really matters. That is why KELLYS bicycle outfit combines not only the highest comfort and durability but also smart and unique design, which make you feel confident and stylish.

COMFORT

KELLYS outfit designers put the biggest effort on comfort and safety features to make riding even more pleasant and confident. Thanks to premium quality fabrics and design, based on human anatomy studies, KELLYS clothes provide optimum thermal comfort. Multi-directional size adjustment systems allows to fit KELLYS outfit to everybody.

PROTECTION

To provide the highest level of security, KELLYS designers reached for the modern safety technologies and features. The helmet protection systems, reflecting elements and many others make you feel secure and confident during cycling.

FUNCTIONALITY

KELLYS outfit is full of smart and unique features. Ingenious pockets, fitting and comfort systems, all of this distinguishes KELLYS products from the others, giving riders smart and simple solutions which will work in any situations.

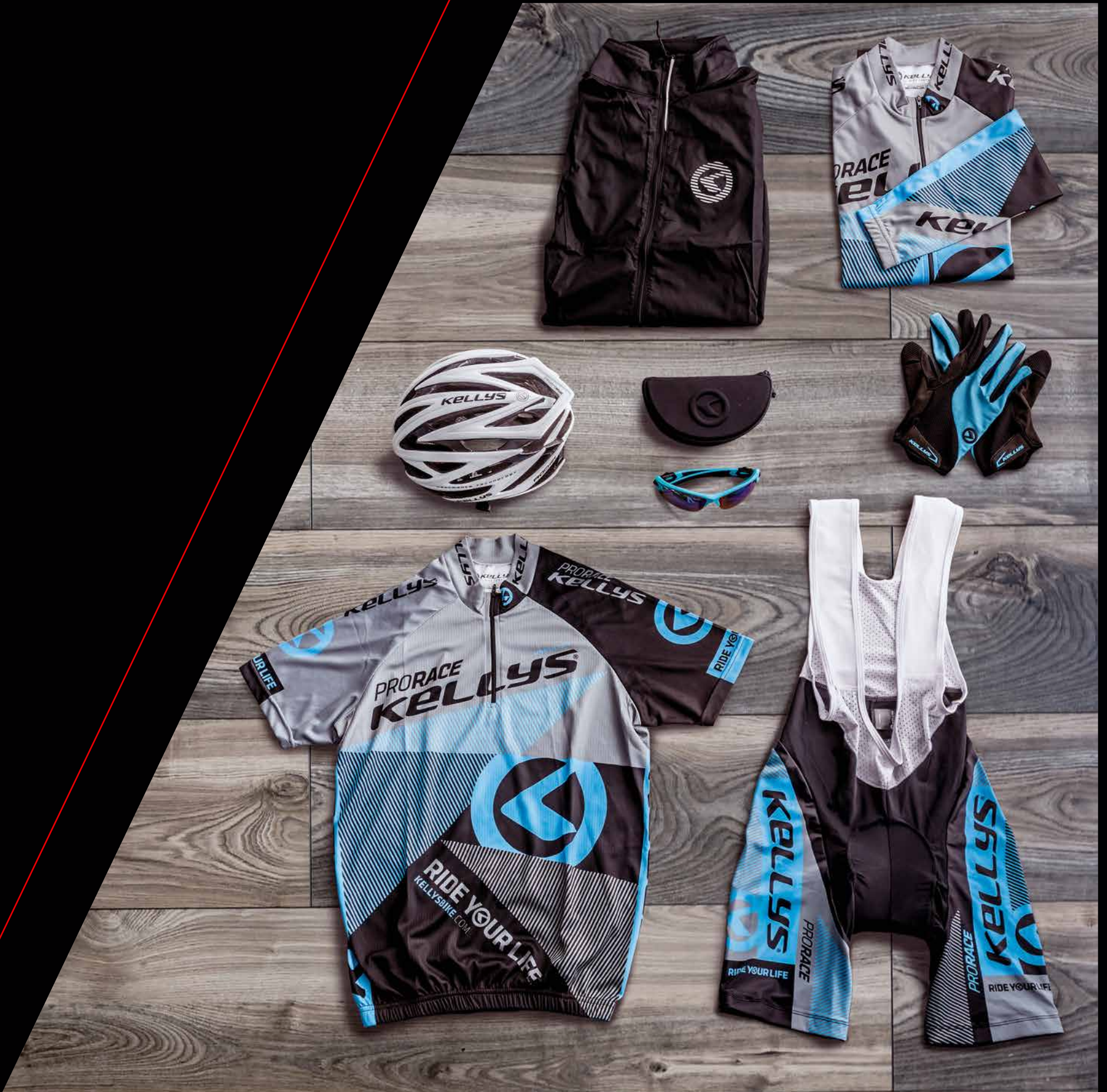





RIDE YOUR LIFE
grey



RIDE YOUR LIFE
lime



RIDE YOUR LIFE
orange

RIDE YOUR LIFE JERSEY SHORT SLEEVE

Loose fit for comfort and freedom of movement. Made of a breathable, soft and comfortable 100% polyester fabric.

COLORS: grey, lime, orange

SIZES: S, M, L, XL, XXL



RIDE YOUR LIFE
grey



RIDE YOUR LIFE
lime

RIDE YOUR LIFE JERSEY LONG SLEEVE

Loose fit for comfort and freedom of movement. Made of a breathable, soft and comfortable 100% polyester fabric.

COLORS: grey, lime

SIZES: S, M, L, XL, XXL



RIDER LOOSE FIT SHORTS

Universal MTB shorts with light but durable outer material Taslan for comfort and wide range of movement. Detachable inner lycra shorts with antibacterial padding. With reflective logos for your safety.

SIZES: S, M, L, XL, XXL



PRO RACE JERSEY SHORT SLEEVE

All-over printed jersey in a special Kellys tam design, made of a breathable, soft and comfortable 100% polyester. It features details like optimum moisture regulation, fast drying, lightweight. Jersey has a front half zipper and 3 back pockets.

COLORS: blue, white, lime, orange
SIZES: S, M, L, XL, XXL



PRO RACE
lime

PRO RACE
orange

PRO RACE
white

PRO RACE
blue

PRO RACE JERSEY LONG SLEEVE

All-over printed jersey made of thermomicrowave fabric, can be worn all around the year. It offers optimum moisture regulation, fast drying, lightweight and comfortable fit. It has a front full-length zipper closure, arm zippers and 3 back pockets.

COLORS: blue, white, lime, orange
SIZES: S, M, L, XL, XXL



PRO RACE
lime

PRO RACE
blue

PRO RACE
white

PRO RACE
orange



PRO RACE
blue

PRO RACE
lime

PRO RACE
white

PRO RACE
orange

PRO RACE BIBSHORT

A special Kellys team designed multi-panel bibshort using a quality fabric polyamide / elasthane with a breathable and antibacterial multi-level padding. With an anti-slip elastic leg grippers to hold bibshorts in the right position and to provide you with the best comfort.

COLORS: blue, white, lime, orange
SIZES: S, M, L, XL, XXL





MISSION:
THE RIDER'S SECOND SKIN





PRO SPORT
red

PRO SPORT
lime

PRO SPORT
blue

PRO SPORT JERSEY SHORT SLEEVE

Jersey in a special Kellys team design, made of a breathable, soft and comfortable 100% polyester fabric. It features details like optimum moisture regulation, fast drying, lightweight. Jersey has a front half zipper and 2 back pockets.

COLORS: lime, orange, red, blue

SIZES: S, M, L, XL, XXL



PRO SPORT
orange



PRO SPORT BIBSHORT

A special Kellys team designed multi-panel bibshort using a quality fabric polyamide / elasthane with a breathable and antibacterial multi-level padding. With an anti-slip elastic leg grippers to hold bibshorts in the right position and to provide you with the best comfort.

COLORS: black

SIZES: S, M, L, XL, XXL





JODY
bronze-azure



JODY
mint-lime

JODY
violet-azure

JODY
coral-azure

JODY
orange-grey

JODY JERSEY SHORT SLEEVE

All-over printed jersey for women in a special design, made of a breathable, soft and comfortable 100% polyester Borgini® fabric. It features details like optimum moisture regulation, fast drying, lightweight. Jersey with a front half zipper and 2 back pockets.

COLORS: coral-azure, mint-lime, violet-azure, bronze-azure, orange-grey
SIZES: S, M, L, XL, XXL

MEGAN CYCLING SHORTS

A special Kellys team designed multi-panel bibshort for women using a quality fabric polyamide / elasthane with a breathable and antibacterial multi-level padding. With an anti-slip elastic leg grippers to hold bibshorts in the right position and to provide you with the best comfort.

COLORS: black,
SIZES: S, M, L, XL, XXL



MEGAN 3/4 CYCLING SHORTS

A special Kellys team designed multi-panel bibshort for women using a quality fabric polyamide / elasthane with a breathable and antibacterial multi-level padding. With an anti-slip elastic leg grippers to hold bibshorts in the right position and to provide you with the best comfort.

COLORS: black
SIZES: S, M, L, XL, XXL



LARA LOOSE SHORTS

Universal loose cycling shorts made from light but durable outer material for comfort and wide range of movement. Detachable inner lycra shorts with antibacterial anatomically shaped multi-level padding. With reflective logos for your safety.

SIZES: S, M, L, XL, XXL





PRO RACE ISOWIND JACKET

In a special Kellys professional team design. It is made of the ITTAI® windproof fabric with a rear panel made of the SuperRoubaix® super stretch thermo fabric for a great insulation and optimal breathability. The jacket has a full-length zipper closure and a high collar keeps wind and moisture off the neck. A back pocket with a zipper has a reflective stripe for your safety
SIZES: S, M, L, XL, XXL



PRO SPORT WIND JACKET

Same fit like our PRO RACE ISOWIND jacket but with simpler look for more leisure rides. Made from combination of WIND BLOCKER membrane and JGrong breathable fabrics. This combination offers you wind protection with optimal breathability. The jacket has a back pocket with reflective piping for your safety
SIZES: S, M, L, XL, XXL



WINDPACK green

WIND PACK JACKET

Ultralight and windproof jacket made of micro-polyamid fibres with rip-stop treatment (against tearing). You can stuff this jacket into its own pocket to put into your back pack or even into your jersey back pocket. So the jacket is always available when the weather turns nasty or for a chilly downhill. There is plenty ventilation thanks to mesh on the back and in the arm pits for higher breathability. With reflective Kellys logo for your safety.

COLORS: black, green
SIZES: S, M, L, XL, XXL



WINDPACK black



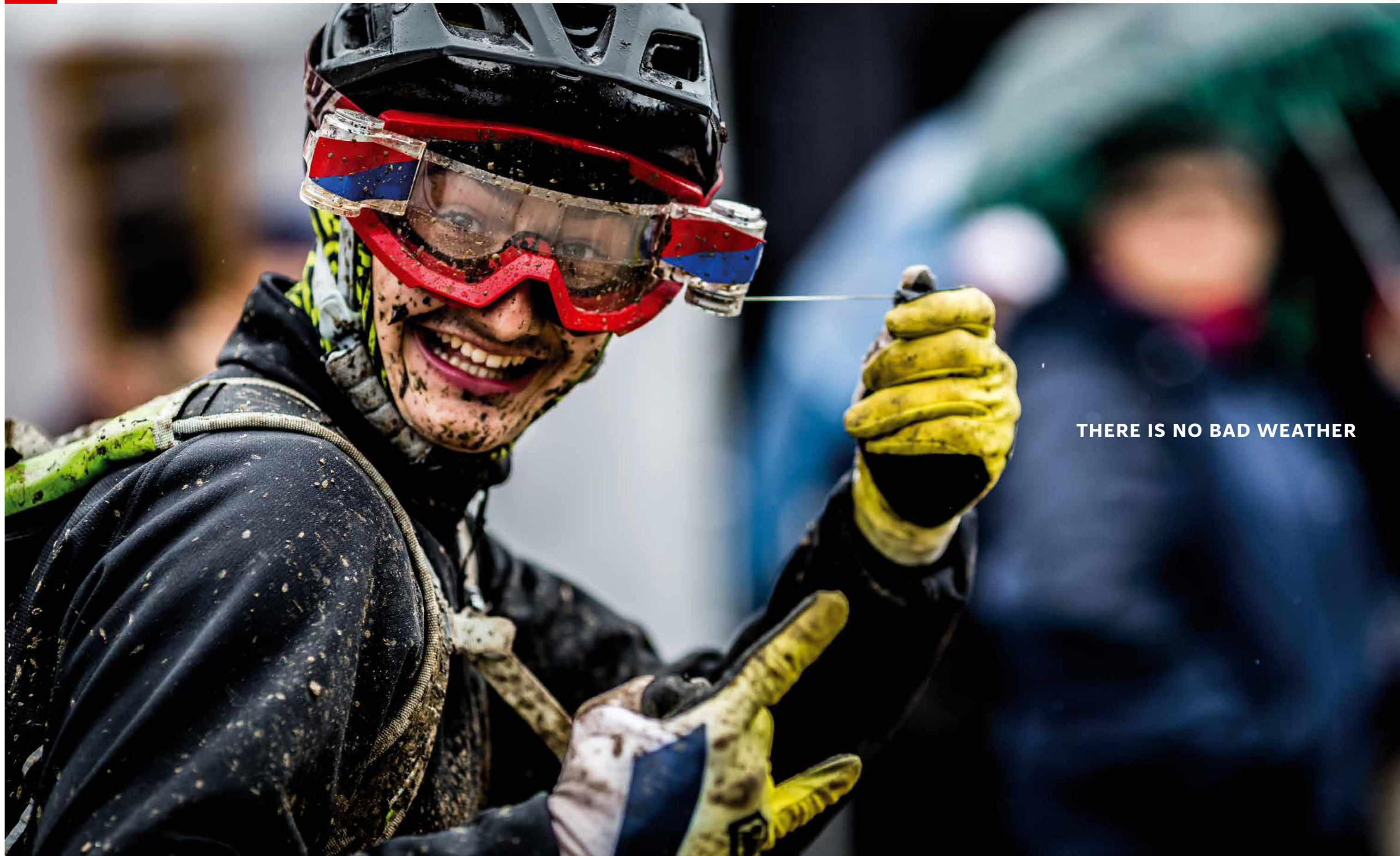

THERE IS NO BAD WEATHER





ARM WARMERS THERMO

Made from functional and elastic thermo fabric with great thermal performance to protect against cold. Their are highly breathable and transports moisture to the outside. With an antislip gripper at the upper part to hold warmers in the right position and Kellys reflective logos for your safety.

Material: 89% polyester, 11% elasthan
SIZES: S, M, L, XL, XXL



KNEE WARMERS THERMO

Made from functional and elastic thermo fabric with great thermal performance to protect against cold. Their are highly breathable and transports moisture to the outside. With an antislip gripper at the upper part to hold warmers in the right position and Kellys reflective logos for your safety.

Material: 89% polyester, 11% elasthan
SIZES: S, M, L, XL, XXL



LEG WARMERS THERMO

Made from functional and elastic thermo fabric with great thermal performance to protect against cold. Their are highly breathable and transports moisture to the outside. With an antislip gripper at the upper part to hold warmers in the right position and Kellys reflective logos for your safety.

Material: 89% polyester, 11% elasthan
SIZES: S, M, L, XL, XXL

THERMO RBX BIBTIGHTS

Made of the SuperRoubaix® super-stretch thermo fabric. These special multi-panel bibtights provides you with a comfortable fit. With or without a breathable and antibacterial Hygienic® multilevel padding. Kellys reflective logo at the back panel for your safety.

SIZES: S, M, L, XL, XXL



THERMO RBX
bibtights with/without padding



CAP WINDBLOCKER

It is designed to be worn under helmet. Made from a combination of different panels for optimal protection and moisture regulation. With Kellys reflective logo for your safety. One size fits all.



THERMO ISOWIND
bibtights with/without padding

THERMO ISOWIND BIBTIGHTS

The front part is made of the Isowind® windproof fabrics and the rear part from SuperRoubaix® super-stretch thermo fabric for colder and windy days. With or without a breathable and anti-bacterial Hygienic® multilevel padding. Kellys reflective logo for your safety.

SIZES: S, M, L, XL, XXL

SHOE COVERS WINDBLOCKER

Made of WINDBLOCKER windproof fabric to keep your feet warm. The covers have a full lenght zipper at the back for comfortable fit with a reflective velctro strap and Kellys logo for your safety.

SIZES: S/37-38, M/39-40, L/41-42, XL/43-44, XXL/45-46



COOLMAX®

wicks sweat away from body keeps you cool, dry and comfortable, lightweights, soft and breathable, DuPont performance tested and certified

SUPERROUBAIX®

fast-recovery super-stretch fabric air permeable, strong, soft comfortable and easy care

ISOWIND®

functional fabric with a comfort and easy care properties:

- waterproof, windproof, water vapour permeable
- longitudinally and diagonally elastic
- keep its shape





PRO RACE white

PRO RACE blue

PRO RACE lime

PRO RACE SOCKS

In a special Kellys professional team design. Made of polyamide for great breathability and durability. Anatomically shaped socks for left and right foot. With a special elastic strap for perfect, stable and comfortable fit.

COLORS: black, white, blue, lime
AVAILABLE SIZES: 38 - 42, 43 - 47



PRO RACE black



PRO SPORT SOCKS

In a special Kellys design. Made of Coolmax® for great breathability and durability. Anatomically shaped socks have a special elastic strap for perfect, stable and comfortable fit.

COLORS: black, white
AVAILABLE SIZES: 38 - 42, 43 - 47

FIT SOCKS

Invisible socks in Kellys design. Made of cotton for great comfort. Anatomically shaped socks have a special elastic strap for perfect, stable and comfortable fit. Also for every day wear.

COLORS: black, white
SIZES: 38 - 42, 43 - 47



labyrinth lime unisex

logo black

ride your life black



illusion yellow

tetris blue

paisley orange

MULTI-FUNCTIONAL SCARF

Possible to wear around neck, like a cap, on wrist or whatever you like 100% polyester

COLORS: paisley orange, logo black, ride your life black, illusion yellow, labyrinth lime, tetris blue





BE A TRUE RIDER -
ANYTIME, ANYWHERE



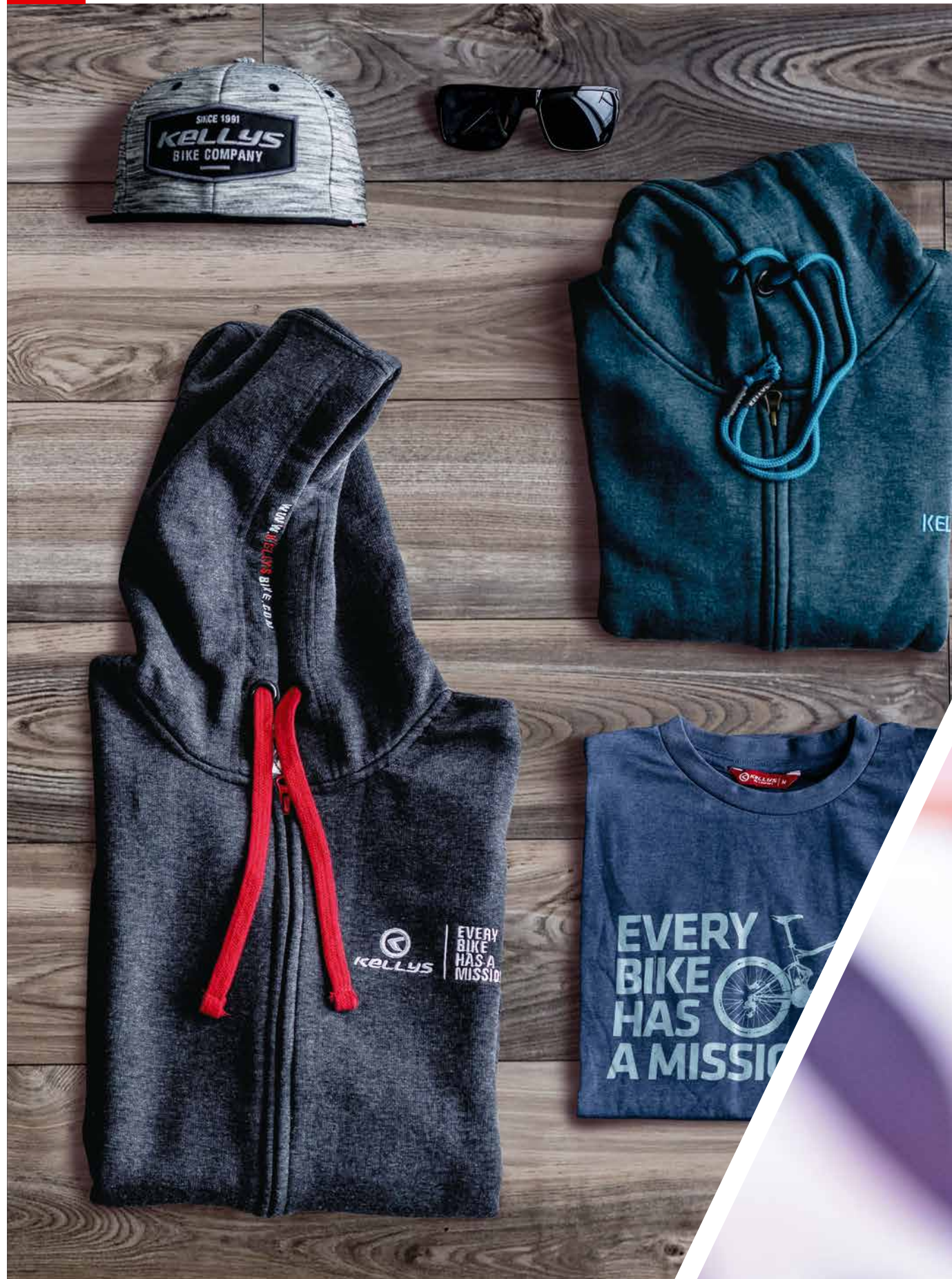



BIKER red

BIKER melange

BIKER WOMENS' T-SHIRT

Body & BNT - 160 GSM Single Jersey
60% Polyester, 37% Cotton, 3% Elastane - Knitted
Rib - 1x1 97% Cotton, 3% Elastane - Knitted
Wash - Softener Bio Wash that provides longevity and smooth hand-feel
SIZES: XS, S, M, L, XL
COLORS: melange, red



BIKE MISSION blue

BIKE MISSION grey

BIKE MISSION WOMENS' T-SHIRT

Body & BNT - 160 GSM Single Jersey
60% Polyester, 37% Cotton, 3% Elastane - Knitted
Rib - 1x1 97% Cotton, 3% Elastane - Knitted
Wash - Softener Bio Wash that provides longevity and smooth hand-feel
SIZES: XS, S, M, L, XL
COLORS: blue, grey



BIKE MISSION blue

BIKE MISSION green

BIKE MISSION MENS' T-SHIRT

Body & BNT - 160 GSM Single Jersey
60% Polyester, 37% Cotton, 3% Elastane - Knitted
Rib - 1x1 97% Cotton, 3% Elastane - Knitted
Wash - Softener Bio Wash that provides longevity and smooth hand-feel
SIZES: S, M, L, XL, XXL
COLORS: blue, green



RIDE YOUR LIFE blue

RIDE YOUR LIFE lime

RIDE YOUR LIFE MENS' T-SHIRT

Body, Rib & BNT - 160 GSM Single Jersey
95% Polyester, 5% Elastane - Knitted
Wash - Softener Wash that provides longevity and smooth hand-feel
SIZES: S, M, L, XL, XXL
COLORS: blue, lime

BASIC HOODIE HOODIE

Body - 340 GSM Brushback Fleece
60% Cotton, 40% Polyester
Rib - 2x2 Rib 97% Cotton 3% Elastane
Hood & Pocket Lining - 160 GSM Single Jersey 100% Cotton
Wash - Softener Bio Wash that provides longevity and smooth hand-feel
COLORS: coral, teal



BASIC teal (women)

BASIC coral (men)



MELANGE blue (men)

MELANGE purple (women)

MELANGE HOODIE HOODIE

Body - 340 GSM Brushback Fleece 60% Cotton, 40% Polyester
Rib - 2x2 Rib 97% Cotton 3% Elastane
Hood & Pocket Lining - 160 GSM Single Jersey 100% Cotton
Wash - Softener Bio Wash that provides longevity and smooth hand-feel
COLORS: blue, purple



SIGN CAP

Original FLEXFIT® cap with flat visor
Comfortable feel
92% acrylic, 15% woll 2% spandex
SIZE: S/M, L/XL



KELLYS BEANIE

100% dry Acrylic knitted beanie with 100% Polyester micro fleece and Pom-pom, woven label.



MELANGE PRIMALOFT BEANIE

100% Acrylic knitted beanie with waterproof Pirmaloft insert lining



3 STRIPES BEANIE

100% Acrylic with Pompom, Insert lining: Thinsulate 3M C40



MULTISTRIPES BEANIE

100% Acrylic knitted beanie with woven label



NO RULES CAP

47% Cotton / 25% Polyester / 28% Nylon
5 Panels
Flat Visor
SIZES: OSFA



RIDE YOUR LIFE CAP

83% Acrylic / 15% Wool / 2% Spandex
6 Panels
Contrast Visor and Top Button
SIZES: S/M , L/XL

SIZE CHART (RACE WEAR)

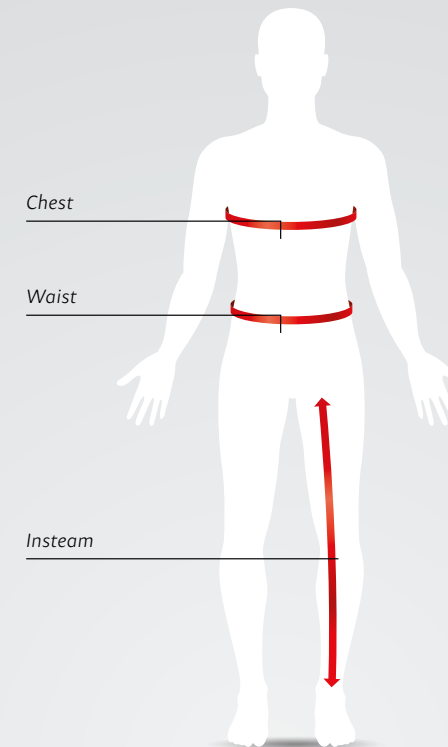

HEIGHT:
Measure from the top of the head to the floor while standing upright.
CHEST:
Measure around your chest, with arms relaxed down at sides. Measure around the fullest part of your chest, make sure the measuring tape will go around your shoulder blades. Keep the tape paralel to the floor.
WAIST:
Measure around natural waistline, keeping the tape a bit loose.
INSEAM:
Measure inside of leg from the crotch to the ankle bone.

MEN'S SIZES:	S	M	L	XL	XXL
HEIGHT:	165-170	170-175	175-180	180-185	185-190
CHEST:	88-92	92-96	96-100	100-106	106-112
WAIST:	75-80	80-84	84-88	88-94	94-100
INSEAM:	81	82	83	84	85
WOMEN'S SIZES:	S	M	L	XL	XXL
HEIGHT:	160-164	164-168	168-172	172-176	176-180
CHEST:	85-90	90-94	94-100	100-106	106-112
WAIST:	68-72	72-76	76-80	80-86	86-92
INSEAM:	75,5	77	78,5	78,5	80





KEEP THE GRIP AND RIDE

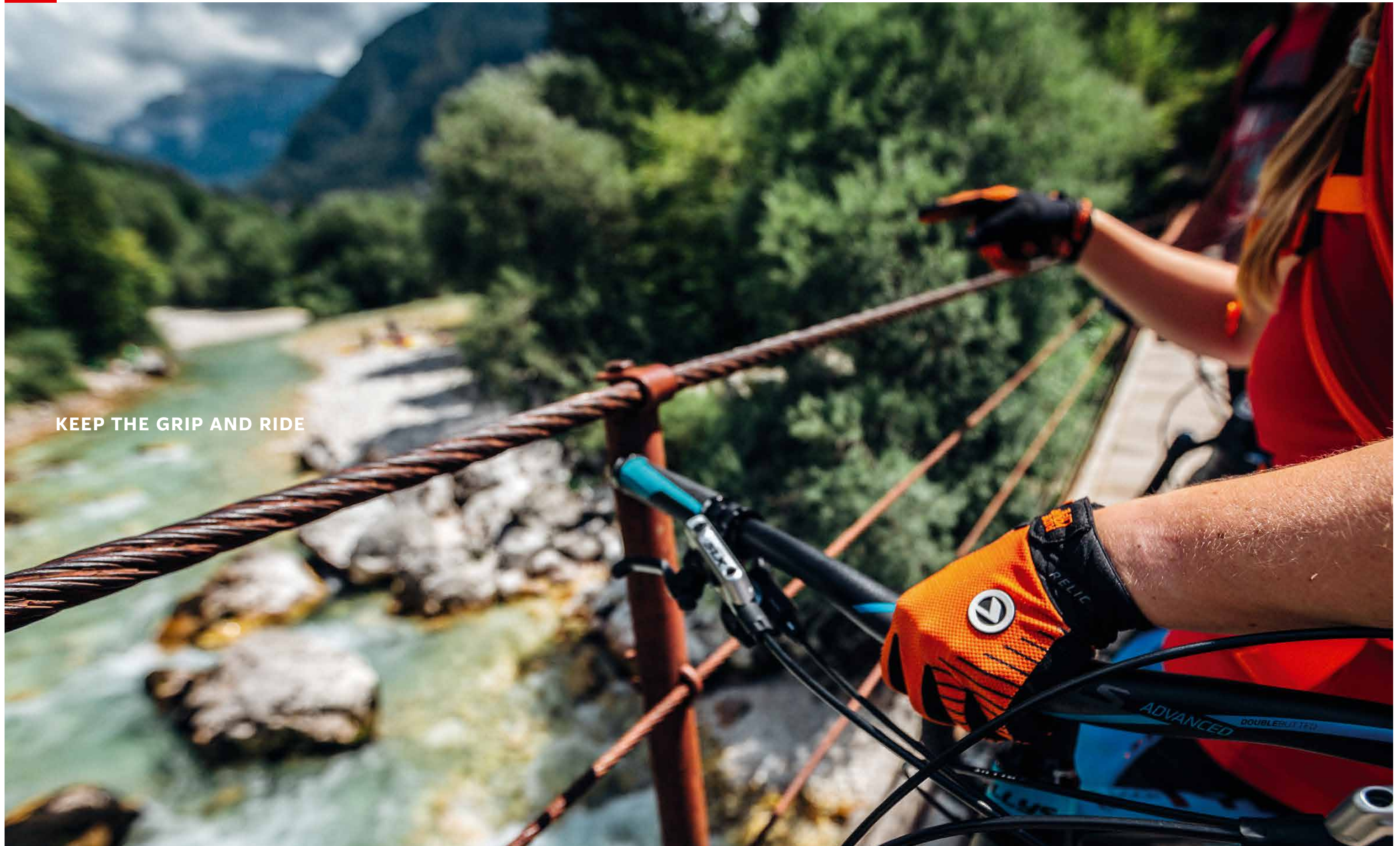



HYPNO LONG GLOVES

Durable and lightweight glove with thin gelfoam padding
Two-way padding system on the palm
Double layer CLARINO synthetic leather on the palm
Silicone fingertips for better grip
Thumb area with micro-suede towel
Wrist tab closure
COLORS: grey, lime, blue
SIZES: S, M, L, XL, XXL (grey only)



RELIC LONG GLOVES

Lightweight glove with no padding
Single layer perforated CLARINO synthetic leather on the palm
Silicone fingertips for better grip
Reinforced thumb area
Neoprene wrist tab closure
COLORS: grey, lime, orange
SIZES: S, M, L, XL, XXL (grey only)



FLOW SHORT GLOVES

Durable and lightweight glove with gelfoam padding
Ergonomic padding on the palm
AX Suede Dence synthetic leather on the palm
Thumb area with micro-suede towel
Wrist tab closure
COLORS: grey, lime, blue
SIZES: S, M, L, XL, XXL (grey only)



RACE GLOVES

Made of Fourway
Ergonomically formed palm from synthetical leather Amara with foam padding
Reinforced thumb area with a towel
COLORS: red, black, blue, grey
SIZES: XS, S, M, L, XL, XXL (black only)



FLOW LONG GLOVES

Durable and lightweight glove with gelfoam padding
Ergonomic padding on the palm
AX Suede Dence synthetic leather on the palm
Silicone fingertips for better grip
Thumb area with micro-suede towel
Wrist tab closure
COLORS: grey, lime, blue
SIZES: S, M, L, XL, XXL (grey only)



HYPNO SHORT GLOVES

Durable and lightweight glove with thin gelfoam padding
Two-way padding system on the palm
Double layer CLARINO synthetic leather on the palm
Thumb area with micro-suede towel
Wrist tab closure
COLORS: grey, lime, blue
SIZES: S, M, L, XL, XXL (grey only)



COMFORT GLOVES

Made of Lycra Mesh
Ergonomically formed palm from synthetical leather Amara with gel padding reinforced thumb area with a towel.
COLORS: red, black-lime, black-white, lime
SIZES: XS, S, M, L, XL, XXL (black-white only)



FROSTY GLOVES

Winter gloves for cold and frosty weather
Made of membrane HYPORA Winbreaker material
Silicone reinforcement of palm and partially fingers for a better grip
Double stitched palm for durability
Wristband for a better protection.
COLORS: black, blue, red, grey
SIZES: S, M, L, XL, XXL (black only)





CATCH THE SIGHT
OF THE TRAIL





STRANGER MONO
black



STRANGER MONO
lime



STRANGER MONO
black

STRANGER MONO SUNGLASSES

100% UVA, UVB and UVC protection up to 400nm
Lightweight frame made of Grilamid TR90
Interchangeable polycarbonate lenses
Antiwater lens coating
Antiscratch lens coating
Antifog lens coating
Cut-out lenses adjust airflow
Comfortable and adjustable nose pads
Injected rubber ends
Patented way of changing lenses
Meet EN standard EN 12312:2013

COLORS: Shiny Black (POLARIZED smoke flash mirror/blue)
Shiny Lime (green REVO/blue)
Shiny Black (PHOTOCHROMATIC smoke)



FORCE
white gloss

FORCE SUNGLASSES

100% UVA, UVB and UVC protection up to 400nm
Lightweight frame made of Grilamid TR90
Interchangeable polycarbonate lenses
Antiwater lens coating
Antiscratch lens coating
Antifog lens coating
Cut-out lenses adjust airflow
Comfortable and adjustable nose pads
Injected rubber ends
Meet EN standard EN 12312:2013

COLORS: Shiny Red (smoke/transparent)
Shiny Black (mint/orange)
Shiny Black PHOTOCHROMIC
White Gloss (violet REVO/smoked)
Shiny Lime (smoke green REVO/yellow)



FORCE
shiny black
PHOTOCHROMATIC



FORCE
shiny lime



FORCE
shiny black



FORCE
shiny red



WRAITH
shiny lime



WRAITH
shiny white



WRAITH
sky blue



WRAITH
crystal ash



WRAITH
shiny black
PHOTOCHROMATIC

WRAITH SUNGLASSES

100% UVA, UVB and UVC protection up to 400nm
Lightweight frame made of Grilamid TR90
Interchangeable polycarbonate lenses
Antiwater lens coating
Antiscratch lens coating
Antifog lens coating
Comfortable and adjustable nose pads
Changeable rubber ends
Meet EN standard EN 12312:2013

COLORS: Black (mint/orange)
Crystal Ash (mint/orange)
Shiny White (smoke flash mirror/yellow)
Shiny Lime (smoke green REVO/orange)
Shiny Black (PHOTOCHROMIC smoke)
Shiny Orange (orange REVO/blue)
Sky Blue (Blue REVO/orange)





STRANGER
shiny white



STRANGER
sky blue



STRANGER
shiny black

STRANGER SUNGLASSES

100% UVA, UVB and UVC protection up to 400nm
Lightweight frame made of Grilamid TR90
Interchangeable polycarbonate lenses
Antiwater lens coating
Antiscratch lens coating
Antifog lens coating
Cut-out lenses adjust airflow
Comfortable and adjustable nose pads
Injected rubber ends
Patented way of changing lenses
Meet EN standard EN 12312:2013
COLORS: Shiny Black (POLARIZED smoke flash mirror/blue
Shiny White (violet REVO/smoked)
Sky Blue (green REVO/blue)



RESPECT
shiny black



RESPECT
shiny white



RESPECT
space black



RESPECT
crystal blue

RESPECT LIFESTYLE SUNGLASSES

100% UVA, UVB and UVC protection up to 400nm
POLARIZED polycarbonate lenses with REVO coating
Lightweight frame made of Grilamid TR90 polycarbonate
Comfortable fit
Antiwater lens coating
Antiscratch lens coating
Antifog lens coating
Meet EN standard EN 12312:2013
COLORS: Shiny Black (POLARIZED smoke flash mirror)
Shiny White (POLARIZED green REVO)
Crystal Ash (POLARIZED blue REVO)
Crystal Blue (POLARIZED green REVO)
Space Black (POLARIZED blue REVO)



PROJECTILE
shiny black
PHOTOCHROMATIC



PROJECTILE
shiny black

PROJECTILE LIFESTYLE SUNGLASSES

100% UVA, UVB and UVC protection up to 400nm
Lightweight frame made of Grilamid TR90
Antiwater lens coating
Antiscratch lens coating
Antifog lens coating
Comfortable and adjustable nose pads
Injected rubber ends
Meet EN standard EN 12312:2013
COLORS: Shiny Black (POLARIZED smoke)
Shiny Black (PHOTOCHROMIC smoke)

FRAME

All types of sun glasses are made of Grilamid TR90, which is characterized by an extremely high flexural strength, flexibility and lightweight. Grilamid TR90 also excellently resists weather conditions and the effects of UV radiation. This material therefore ensures a long frame durability even during high performance.

POLYCARBONATE LENSES

These lenses are characterized by lightweight and depending on the finish also by high durability and scratch-resistance.

PHOTOCHROMIC LENSES

Photochromic lenses are made of Polycarbonate. Depending on the intensity of UV radiation the lenses will be darker. If the UV radiation is removed (indoors or inside the car), the lenses will return to their clear state. These lenses are recommended to use outdoor only.

POLARIZED LENSES

The sun light itself is not polarized – it becomes polarized after the impact on a shiny surface (snow, water surface or road), when the reflected waves oscillate in two levels – horizontal and vertical. Sunglasses with polarized filter allow only the positive vertically reflected rays to reach your eye. Looking through such sunglasses is comfortable, clear and without glare. The horizontal group of sun rays is blocked out by the polarized filter. These lenses allow a colorful vision, better visual clarity and notable relief for the eyes.

ANTI-SCRATCH COATING

All lenses are equipped with special surface treatment which increases scratch resistance.

ANTI-FOG COATING

This lens treatment prevents fogging for certain time to avoid reduced visibility.

ANTI-WATER COATING

Surface treatment improves off-take of water droplets. It helps to keep the vision clear and without any distortion.



FILTER CATEGORY	TINT	USE	LIGHT TRANSMITTANCE	
			From %	To %
0	Clear / Very Light	Cloudy, Evening	80	100
1	Light Tint	Cloudy Conditions	43	80
2	Medium Tint	Regular Conditions	18	43
3	Dark Tint	Sunny Conditions (sea, mountains)	8	18
4	Very Dark*	Very Sunny (glacier)	3	8

*Inappropriate for driving a vehicle and for using in road traffic



RAZOR

ENDURO HELMET
WITH MIPS®



HELMET RAZOR WITH MIPS®

Razor helmet with integrated MIPS® brain protection system provides you whole new dimension in added safety, comfort and style – all you need to do is just ride. MIPS® Brain Protection System in Razor helmet gives you added protection against rotational violence. Razor with MIPS® is our top Enduro and MTB helmet made with In-mold technology. 23 air channels and rear vents for perfect head ventilation and optimum airflow. New adjusting system provides 5 vertical adjustable positions in the rear part and 2 adjustable positions in front part. With HD Camera Platform you can easy mount your action camera on the top of the shell. Because style really matters, you can match your Razor perfectly to your preferences and find your own colour combination. Each Razor comes with additional spare visor and soft fabric protective bag.

WHEN HITTING THE MOST DEMANDING TRAILS THE ONLY THING YOU WANT TO FOCUS ON IS JUST RIDING. YOUR CONFIDENCE CANNOT BE SACRIFICED FOR ANYTHING ELSE, ESPECIALLY FOR SAFETY AND COMFORT. THEREFORE KELLYS DESIGN TEAM CREATED A BRAND NEW RAZOR – ONE OF THE MOST ADVANCED ENDURO HELMETS EVER PRODUCED.



RAZOR
Juicy Orange
Ruby Red Visor

Because of today's enduro high safety demands, Razor's lightweight shell is made of energy-absorbing materials with in-mould technology. The extended rear part is essential for protecting the back of the head – the most fragile part of your skull. The durable visor secures you against sun reflexes, rain and branches, and is fully adjustable. The specially designed MIPS® low friction layer is placed between the shell and the liner. During an angled impact it allows helmet to slide relative to the head, reducing strain otherwise transmitted to the brain. The best enduro helmet is also a matter of comfort. Thanks to the multi-directional size adjustment system and two shell sizes you can perfectly fit Razor to stay on the trail longer without any discomfort. 23 ventilation holes keep you cool and fresh. The removable lining pads are easy to wash. Enduro and trail riding are full of wonderful moments that you want to record. With Razor's HD Camera Platform you can very easily mount your action camera on the top of the shell. If you feel confident you have to look confident. That's why you can combine 6 different paints of helmet and 8 visors to match your individual style. You can also choose one of inner padding colours: green, gray or blue.

BENEFITS

- Thanks to MIPS Brain Protection System Razor gives added protection against rotational violence to the brain during an angled impact.
- Razor allows you to stay cool and comfortable on trail much longer than other helmets.
- Because style really matters, you can match your Razor perfectly to your preferences and find your own colour combination. Each Razor comes with an additional spare visor.
- Razor provides you with safety, comfort and style – all you need to do is just ride. Ride hard.
- To prevent accidental damage of your Razor and keep it in fine shape for a long time each helmet comes with a special protective bag.



Analytical section of the RAZOR helmet displaying the MIPS low friction layer

THIS IS HOW MIPS WORKS TAKING A FALL WITH A MIPS HELMET IS VERY DIFFERENT

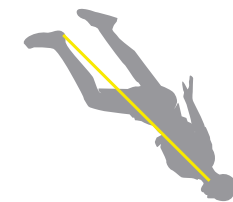

Almost every time you fall*, you fall at an angle. This generates rotational violence to the brain causing concussions and more severe injuries.

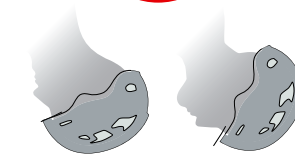

A TRADITIONAL HELMET

Helmets are designed and optimized for a straight fall, giving no consideration to the angled impact. All rotational violence is absorbed by the head and the brain.



RAZOR HELMET EQUIPPED WITH MIPS®

MIPS is a low friction layer inside the helmet that makes the outer shell of the helmet to rotate relative to the head. This can reduce strain in the brain during angled impacts.

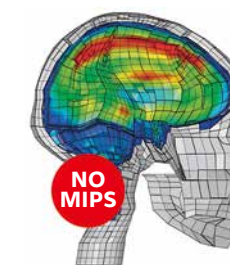
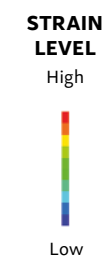

? Rotational violence with standard helmet

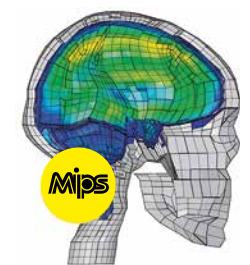

✓ Rotational violence using a helmet with MIPS®





Protection system:



SPARE VISORS AVAILABLE:

space black, dusty grey, ocean blue, lime green, blueberry syrup, ruby red, juice orange, candy pink



COLORS FOR RAZOR AND RAZOR MIPS:

ocean blue (main visor - lime green, spare visor - ocean blue)
lime green (main visor - ocean blue, spare visor - lime green)
light blue (main visor - dusty grey, spare visor - blueberry syrup)
juicy orange (main visor - ruby red, spare visor - juice orange)
space black (main visor - space black, spare visor - juice orange)
tiffany green (main visor - candy pink, spare visor - dusty grey)
SIZES : S/M (54-57 cm), L/XL (57-61 cm)



RAZOR juicy orange

RAZOR HELMET

Razor helmet provides you safety, comfort and style - all you need to do is just ride. Razor is our top Enduro and MTB helmet made by In-mold technology. 23 air channels and rear vents for perfect head ventilation and optimum airflow. New adjusting system provides 5 vertical adjustable positions in rear part and 2 adjustable positions in front part. With HD Camera Platform you can easy mount your action camera on the top of the shell. Because style really matters, you can match your Razor perfectly to your preferences and find your own colour combination. Each Razor comes with additional spare visor and soft fabric protective bag.



SCORE HELMET

Top MTB model made by In-mould technology 23 air vents, air channels and rear vents for perfect head ventilation and optimum airflow STL 2.0 (Simply Twist Lock 2.0) new vertically adjustable head lock system for snug and secure fit, anti-insect internal netting, removable visor, inner padding for comfort.



COLORS:

black-monochrome
black-blue-lime
red-black
white-black
lime-black

NEON COLORS:

orange
yellow
green
sky blue

SIZES: S/M (54-57 cm), M/L (57-61 cm)





ROCKET HELMET

Made by In-mold technology IRS . In-molded Reinforced Skeleton is an advanced skeleton that is fused with the helmet for extra strength in the event of impact WWV22 . Wide Wind Ventilation - helmet features 22 air vents as a combination of active vents and internal exhaust channels that force cool air over and around your head and warm air out. STS - Simply Twist System provides quick and comfortable head size adjustment inner antibacterial padding for comfortable wearing, anti-insect internal netting.

COLORS: black-blue, black-lime, polar white, pure black
SIZES: S/M (56-58cm), L/XL (58-62cm)



DARE HELMET

All-mountain model made by In-mould technology 23 air vents, air channels and rear vents for perfect head ventilation and optimum airflow STL 3.0 (Simply Twist Lock 3.0) new vertically adjustable head lock system for snug and secure fit, anti-insect internal netting, removable visor, inner padding for comfortable wearing.

COLORS: lime green, sky blue, white-black, black-green, anthracite grey, red-black
SIZES: S/M (54-57cm), M/L (58-61cm)



DIVA HELMET

Made by In-mold technology 20 vents for perfect head ventilation inner padding for comfortable wearing, double-pull adjust system, anti-insect internal netting, and visor.

COLORS: white-grey matt, pink- white matt, blue-white, black-grey matt, purple-lime
SIZES: S/M (56-58cm), M/L (58-61cm)



DYNAMIC HELMET

Made by In-mold technology, 20 vents for perfect head ventilation, head adjustment, STL 3.0 (Simply Twist Lock 3.0) new head lock system for snug and secure fit, inner padding for comfortable wearing, anti-insect internal netting and visor.

COLORS: white - red, white - alpine purple, white - arctic blue, white-green, black - sun yellow, black - green
SIZES: S/M (54-58cm), M/L (58-61cm)



REBUS HELMET

Made by In-mold technology 20 vents for perfect head ventilation inner padding for comfortable wearing double-pull adjust system, anti-insect internal netting and visor.

COLORS: lime matt, black matt, white matt, grey-orange, white - grey
SIZES: S/M (56-58cm), M/L (58-61cm)



BLAZE HELMET

19 vents for perfect head ventilation, easy and quick head size adjustment, STL 3.0 (Simply Twist Lock 3.0) new head lock system for snug and secure fit, inner padding for comfortable wearing and visor.

COLORS: white-red, white-blue, black-green, black-grey, white-purple (matt), white-black (matt)
SIZES: S/M (54-57cm), M/L (58-64cm)





**MISSION:
THE KEY TO RIDER'S SAFETY**





TOWN CAP HELMET

Made by In-mold technology with 10 huge vents for perfect head ventilation. Inner padding for comfortable wearing with fabric visor.
COLORS: black matt, white matt, navy blue, ruby red, neon lime
SIZES: S/M (54-57cm), M/L (57-61cm)



JUMPER HELMET

BMX/Dirt model with an EPS Inner shell designed to absorb the force of an impact, high of ABS outer shell strength provides protection, 12 air vents for cooling STL 3.0 (Simply Twist Lock 3.0) new vertically adjustable system for snug and secure fit, inner padding for comfort.
COLORS: white, black, blue
SIZES: S/M (54-57cm), M/L (58-61cm)

SLEEK HELMET

Made by In-mold technology, 8 huge vents for perfect head ventilation, new head lock system with safety light. Inner padding for comfortable wearing.
COLORS: black matt, white matt, mat turquoise, navy blue, neon lime, juicy orange
SIZES: S/M (54-57cm), M/L (57-61cm)



MARK KIDS HELMET

Dial Ring System - easy, quick adjusting and safe fixation on the head, shock absorption, 14 vents for full ventilation, anti-insect netting, integrated visor, antibacterial padding.
COLORS: blue, red, white, black, green, orange, pink
SIZES: XS/S (47-51cm), S/M (51-54cm)



BUGGIE KIDS HELMET

Made by In-mold technology, 12 vents for full ventilation, easy and quick head size adjustment, inner padding, anti-insect internal netting, integrated visor.
COLORS BOY: red, blue, lime, black-lime
COLORS GIRL: pink flower, white flower, red flower, green flower
SIZES: S (48-52cm), M (52-56cm)

SMARTY KIDS HELMET

Made by In-mold technology, 14 vents for full ventilation, easy and quick head size adjustment, inner padding, anti-insect internal netting, integrated visor.
COLORS: graffiti white, graffiti red, graffiti black, blue smile, red smile
SIZES: S (51-54cm), M (54-58cm)





**MISSION:
THE MULTI-TASKING CARRIER**





LANE 10 BACKPACK

Made of Nylon 210D ripstop PU coated – durable and lightweight fabric
 Helmet carriers for Full face and MTB helmet (straps are hideable)
 Knee/elbow pad holder (straps are hideable)
 Water bladder compartment (carry up to 3l water bladder)
 Sunglasses/goggles padded compartment
 Inside sections for small goods such as tube, tire levers, pump, tools etc.
 Flexible and breathable hip belt straps
 Waterproof cover
 Tail light clip
VOLUME: 10L



LANE 16 BACKPACK

Made of Nylon 210D ripstop PU coated – durable and lightweight fabric
 Helmet carriers for Full face and MTB helmet (straps are hideable)
 Knee/elbow pad holder (straps are hideable)
 Separate section for water bladder (carry up to 3l water bladder)
 Sunglasses/goggles padded compartment
 Inside sections for small goods such as tube, tire levers, pump, tools etc.
 Flexible and breathable hip belt straps
 Waterproof cover
 Tail light clip
VOLUME: 16L





FETCH 25 BACKPACK

Made of Nylon 210D ripstop PU coated – durable and lightweight fabric
 Helmet carriers for Full face and MTB helmet (straps are hideable)
 Knee/elbow pad holder (straps are hideable)
 Separate section for water bladder (carry up to 3l water bladder)
 Sunglasses/goggles padded compartment
 Inside sections for small goods such as tube, tire levers, pump, tools etc.
 Flexible and breathable hip belt straps
 Waterproof cover
 Tail light clip
VOLUME: 25L



TRANSIT TRAVEL BACK

Made of Polyester 600D PU coated – durable and long lasting fabric
 Travel bag in cabin luggage size (55 cm x 38 cm x 20 cm will fit most of the airlines)
 Skate silicone wheels
 Shoes compartment (shoes are separated from everything else)
 Laptop compartment (soft padding with EVA foam)
 Tablet compartment and document organiser
 2 inside organizers for small goods.
 3 positions aluminium alloy handle
VOLUME: 40L (expandable to 60L)





BICYCLE

Every rider has a different needs, as the bicycle has a different mission to fulfill. It is very important for KLS to provide smart and stylish accessories, to prepare bicycles even better for their mission and allow riders to show their unique style. Customize your bike and make it one of its kind!



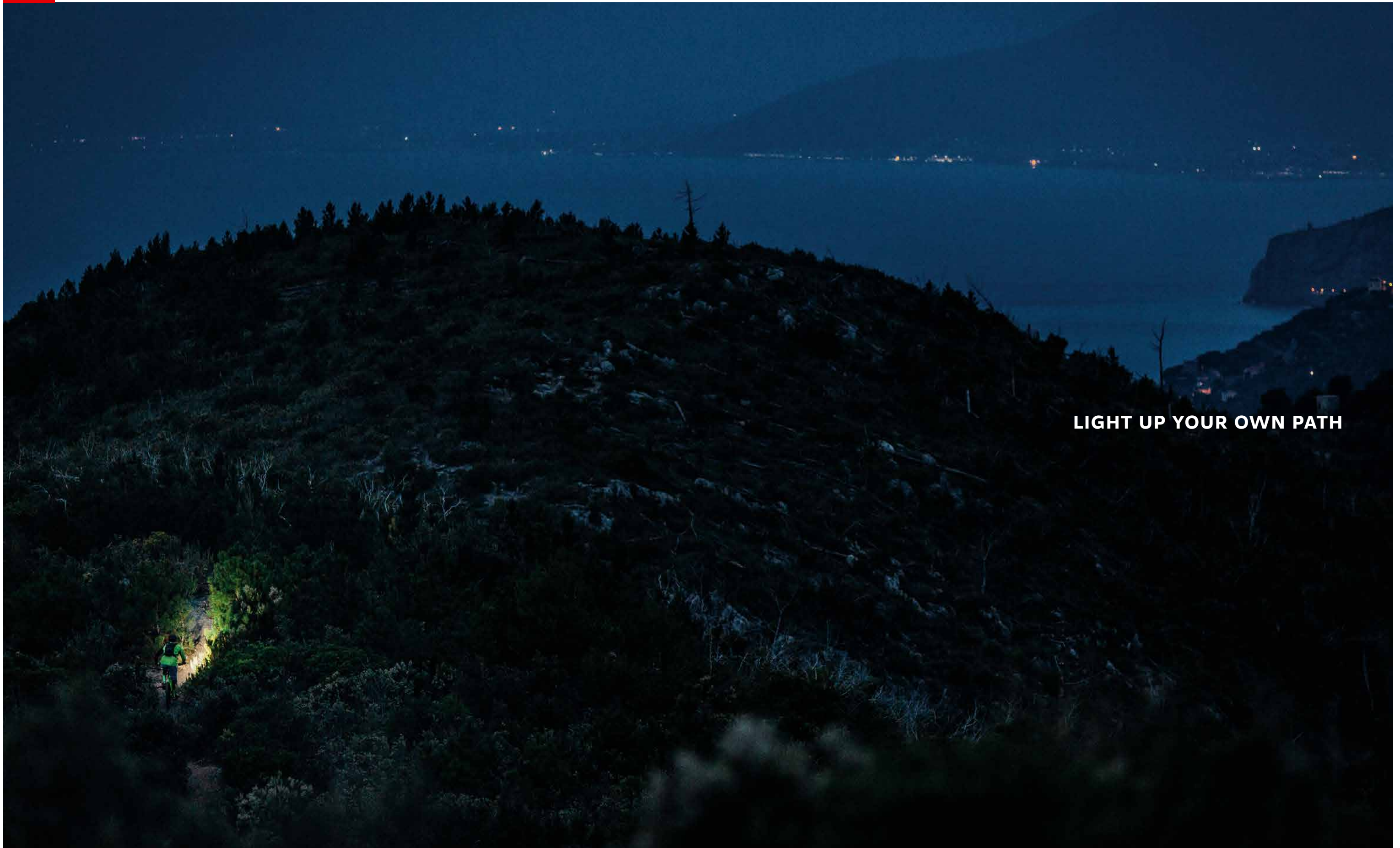

LIGHT UP YOUR OWN PATH



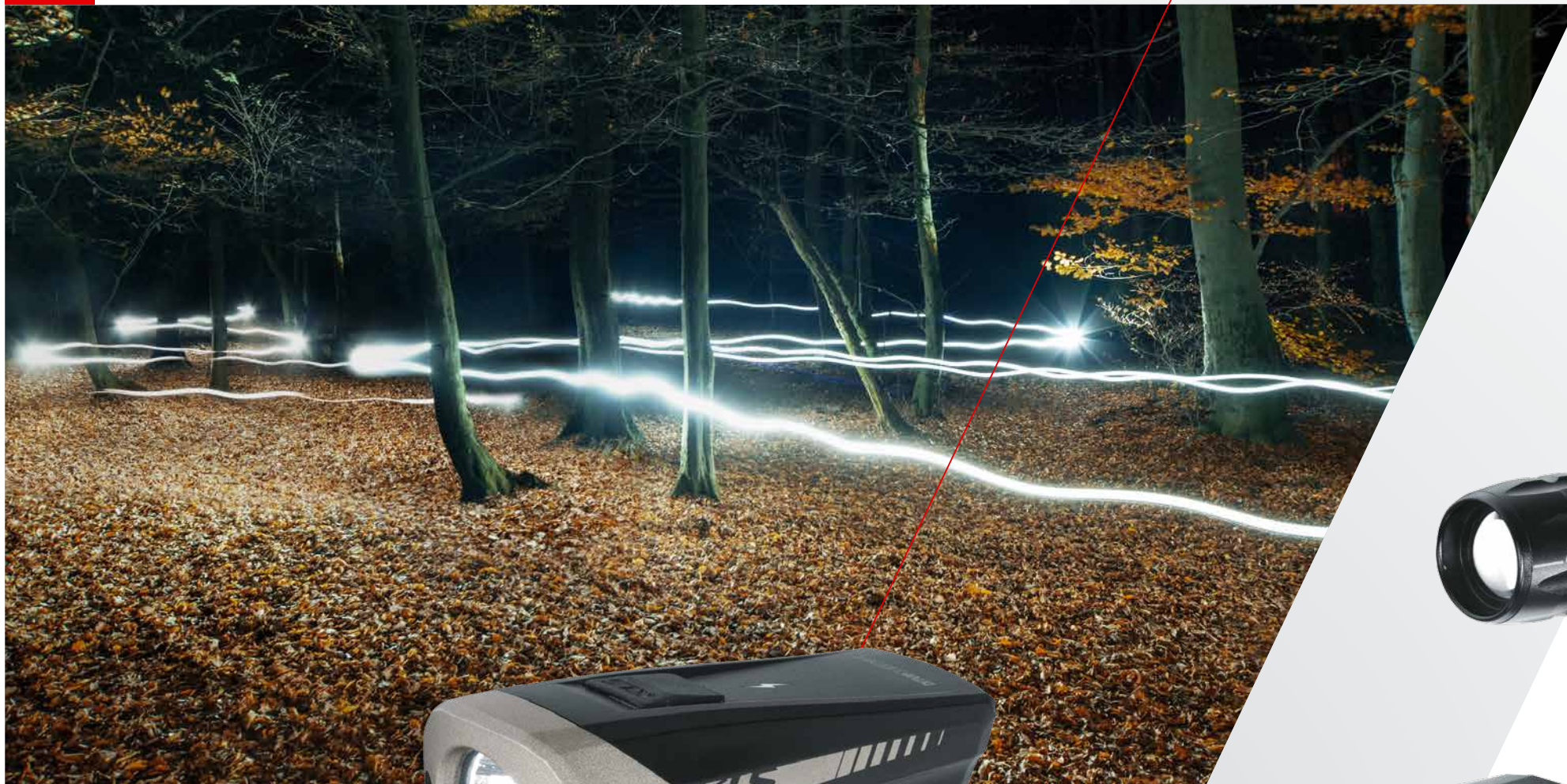

170 LUMEN



SPITFIRE RECHARGEABLE HEADLIGHT

Everything you expect from good bicycle light
Aluminum head for extra cooling
Silicone strap for truly universal use
Adjustable horizontally - 360°
Functions: 100%, 66%, 33%, Flashing
COLOR: Black



RECHARGEABLE
ALUMINIUM HEADLIGHT



TRION HEADLIGHT

Powerful, reliable, battery-powered headlight.
Adjustable horizontally - 360°
Functions: 100% 66% 33%
COLOR: Black



ZOOMER HEADLIGHT

Designed to be your true traveling companion
Great for biking, great for camping
Zoom Lens – adjustable light cone helps you to see exactly what you need
Can be also used well as a torch for any other free-time activity
Adjustable horizontally - 360°
Functions: 100% - Off - 50% - Off - Flashing - Off
COLOR: Black

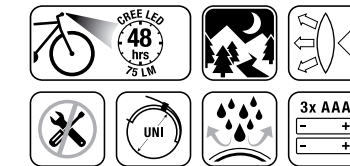

INDEX F RECHARGEABLE HEADLIGHT

Stylish headlight, designed for urban use
Adjustable horizontally - 10°
Functions: 100%, 50%, Flashing
COLOR: Black, White

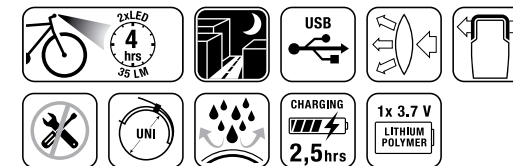

IO F HEADLIGHT

CNC aluminum
Stylish headlight, designed for urban areas
Functions: 100%, Flashing
COLOR: Red, Blue, Silver, Black





REVOLT HEADLIGHT

High-power headlight, made for every-day use
Adjustable horizontally - 15°
Functions: 100%, Flashing, Strobe
COLOR: Black



HUMBLE HEADLIGHT

Designed for urban areas
Functions: 100%, Flashing
COLOR: Black, White



INDEX R RECHARGEABLE TAILLIGHT

Stylish taillight, designed for urban use
Adjustable vertically - 90°
Functions: 100%, 50%, Flashing
COLOR: Black, White



IO R TAILLIGHT

CNC aluminum
Stylish taillight, designed for urban areas
Functions: 100%, Flashing
COLOR: Red, Blue, Silver, Black



ELEMENT TAILLIGHT

Designed for riders who ride long night routes, outside of town
Adjustable vertically - 15°
Functions: 100%, Flashing, Strobe



RIPPY TAILLIGHT

Designed for busy traffic in city areas
Adjustable vertically - 15°
Functions: 100%, 50%, Flashing



NIBIRU RECHARGEABLE TAILLIGHT

Stylish USB rechargeable taillight
Designed for urban use
Functions: 100%



TOPPER TAILLIGHT

Designed for urban areas
With reflective area in its center
Adjustable vertically - 90°
Functions: 100%, Flashing 1,2,3

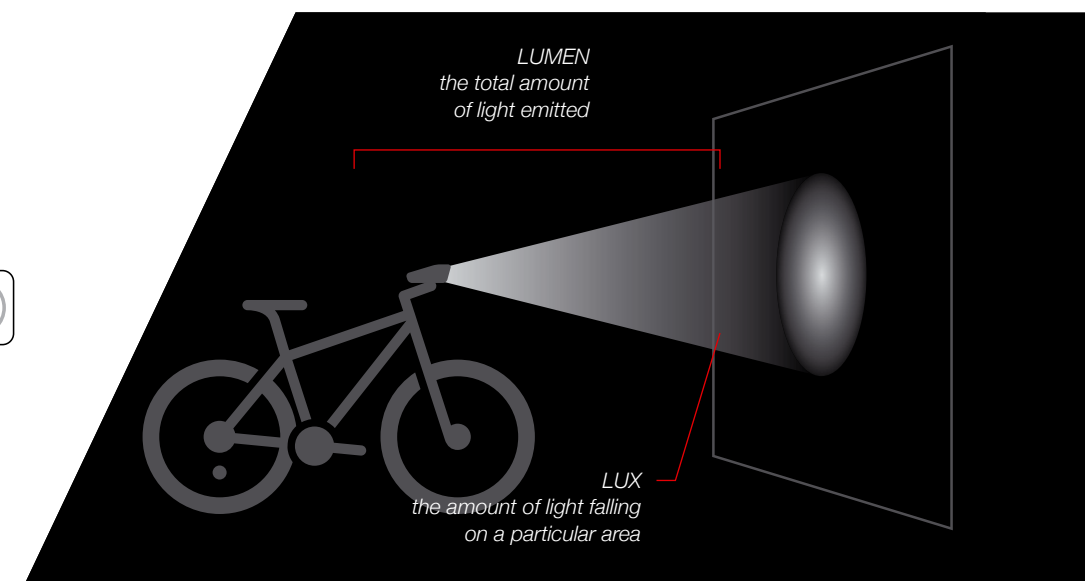



KEPLER REAR CARRIER LIGHT

Stylish rear carrier light
Mount size 50mm/80mm
Functions: 100%



RACKOON REAR CARRIER LIGHT

Mount size 50mm/80mm
Functions: 100%



STRIKE SET HEADLIGHT

High-power headlight, made for every-day use
Adjustable horizontally - 15°
Functions: 100%, Flashing, Strobe



TAILLIGHT

Designed for urban areas
With reflective area in its center
Adjustable vertically - 90°
Functions: 100%, Flashing 1,2,3



GLARE SET HEADLIGHT

High-power headlight, made for every-day use
Functions: 100%, Flashing, Strobe



TAILLIGHT

Designed for busy traffic in city areas
Adjustable vertically - 90°
Functions: 100%, 50%, Flashing

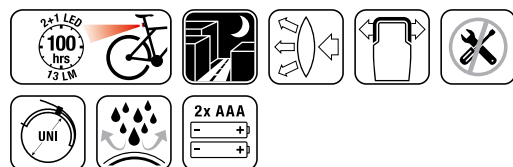

IO SET HEADLIGHT / TAILLIGHT

CNC aluminum
Stylish taillight, designed for urban areas
Functions: 100%, Flashing
COLOR: Red, Blue, Silver, Black

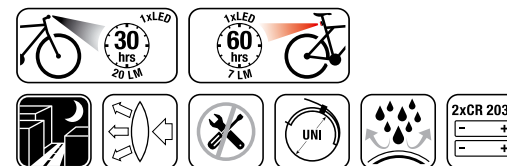

NOBLE SET HEADLIGHT

Designed for urban areas
Functions: 100%, Flashing, Strobe

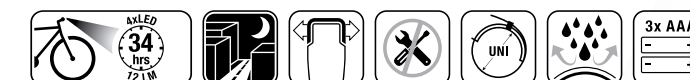

TAILLIGHT

Designed for well-lit urban areas
Functions: 100%, 50%, Flashing



EGGY SET HEADLIGHT / TAILLIGHT

Designed for well-lit urban areas
Functions: 100%, Flashing
COLOR: White, Lime Green,
Sky Blue, Red, Black, Silver

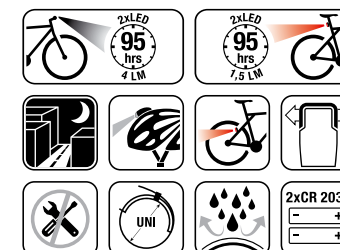

TWINS SET HEADLIGHT / TAILLIGHT

Designed for well-lit urban areas
Functions: 100%, Flashing
COLOR: Black, White, Sky Blue,
Red, Orange, Lime Green

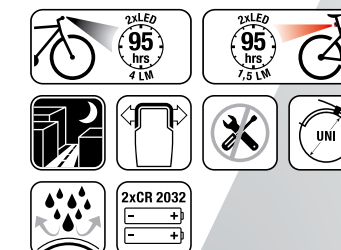



LIGHT NAME	FUNCTION	LUMEN (LM)	BATTERY LIFETIME	USB RECHARGEABLE	MOUNT SIZE	TOOL FREE INSTALLATION	WATER RESISTANT	LIGHTING TYPE	BATTERY
SPITFIRE	High	170	2,2	•	Uni	•	•	1x CREE LED	Li-pol 8,4V 1000mAh
	Mid	86	4,5						
	Low	42	6,5						
	Flashing	170	13,5						
TRION	High	100	10	-	Uni	•	•	1x LED	3x AAA
	Mid	66	13						
	Low	33	16						
	Flashing	100	10						
ZOOMER	High	75	48	-	Uni	•	•	1x CREE LED	3x AAA
	Mid	38	96						
	Low	19	192						
	Flashing	75	96						
INDEX F	High	35	4	•	Uni	•	•	2x White LED	Li-Ion 3,7V 300mAh
	Mid	18	8						
	Low	9	16						
	Flashing	35	8						
REVOLT	Steady	42	48	-	Uni	•	•	1x LED	3x AAA
	Flashing	42	96						
	Strobo	42	96						
	Steady	16	90						
HUMBLE	Flashing	16	180	-	Uni	•	•	5x White LED	3x AAA
	Steady	16	180						
	Flashing	20	30						
	Steady	20	90						
IO F	Flashing	20	90	-	Uni	•	•	1x LED	2x CR 2032 3V
	Steady	20	90						
	Flashing	20	90						
	Steady	20	90						
NIBIRU	Steady	15	3,5	•	Uni	•	•	3x LED	Li-pol
	Flashing	15	3,5						
	Steady	15	3,5						
	Flashing	15	3,5						
INDEX R	High	9	4	•	Uni	•	•	2x Red LED	Li-Ion 3,7V 300mAh
	Mid	4,5	8						
	Low	2,2	16						
	Flashing	9	4						
ELEMENT	Steady	23	60	-	Uni	•	•	2X LED	2X AAA
	Flashing	23	120						
	Strobo	23	120						
	Steady	13	140						
RIPPY	Flashing	10	168	-	Uni	•	•	1x LED	2x AAA
	Strobo	13	280						
	Steady	7	60						
	Flashing	7	120						
IO R	Steady	7	60	-	Uni	•	•	1x LED	2x CR 2032 3V
	Flashing	7	120						
	Steady	2,5	48						
	Flashing	2,5	95						
TOPPER	Flashing 1	2,5	95	-	Uni	•	•	4x Red LED	2x CR 2032 3V
	Flashing 2	2,5	95						
	Flashing 3	2,5	95						
	Steady	2,5	95						
KEPLER	Steady	2	180	-	50/80mm	-	•	2x LED	2xAA
	Flashing	2	180						
	Steady	0,9	180						
	Flashing	0,9	180						
RACKOON	Steady	0,9	180	-	50/80mm	-	•	3x LED	4xAAA
	Flashing	0,9	180						
	Steady	49	52						
	Flashing	49	104						
STRIKE SET	HEAD LIGHT	49	104	-	Uni	•	•	1x LED	3x AAA
	TAIL LIGHT	49	104						
	Flashing 1	2,5	48						
	Flashing 2	2,5	95						
GLARE SET	HEAD LIGHT	47	75	-	Uni	•	•	1x LED	3x AAA
	TAIL LIGHT	47	150						
	Flashing	13	100						
	Flashing	13	200						
NOBLE SET	HEAD LIGHT	12	34	-	Uni	•	•	4x White LED	2XAAA
	TAIL LIGHT	12	68						
	Flashing	12	68						
	Strobo	12	68						
IO SET	HEAD LIGHT	1,2	80	-	Uni	•	•	2x Red LED	2x CR 2032 3V
	TAIL LIGHT	1,2	160						
	Flashing	1,2	160						
	Strobo	1,2	160						
EGGY SET	HEAD LIGHT	20	30	-	Uni	•	•	1x LED	2x CR 2032 3V
	TAIL LIGHT	20	90						
	Flashing	7	60						
	Steady	7	120						
TWINS SET	HEAD LIGHT	4	95	-	Uni	•	•	2x White LED	2x CR 2032 3V
	TAIL LIGHT	4	150						
	Flashing	1,5	95						
	Steady	1,5	150						
TWINS SET	HEAD LIGHT	3,7	70	-	Uni	•	•	2x White LED	2x CR 2032 3V
	TAIL LIGHT	3,7	140						
	Flashing	3,7	140						
	Strobo	3,7	140						
TWINS SET	HEAD LIGHT	1,4	70	-	Uni	•	•	2x Red LED	2x CR 2032 3V
	TAIL LIGHT	1,4	140						
	Flashing	1,4	140						
	Strobo	1,4	140						

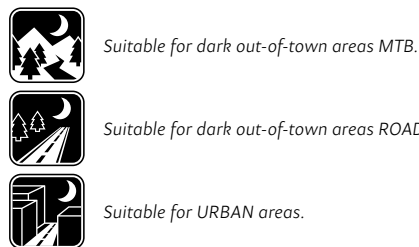
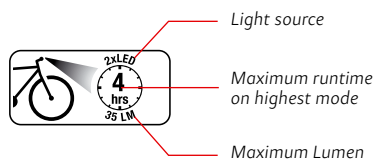

- USB rechargeable.
- Optical Lens System. Lens made to enhance the luminous power to maximum.
- Side Safety System. Light casing spreads the light to the sides for rider's better protection.
- Simple ToolFree installation.
- Universal bracket for all sizes of handle bars (Headlight) or seat posts (Taillight)

- Can be easily mounted on helmet.
- Rear Triangle Attachment. Can be easily mounted to rear triangle.
- Water resistant. No rain will stop your ride.
- Time required to fully charge the batteries.
- Battery type used. All KLS lights include battery.



SHADOW REFLECTIVE ARMBAND

Made of high gloss 3M Scotchlite reflective film
Back side made of 100% polyester velvet fabric
Tested and certificated by TÜV Rheinland, Germany
Conforms to CE EN 13356
SIZES : 3x30cm, 3x40cm



TWILIGHT REFLEX TAPE

Made of 100% Polyester
Tested and certificated by TÜV Rheinland, Germany
Conforms to CE EN 13356
SIZES: 4x40cm, 4x50cm



SPARKY LED ARMBAND

Made of high gloss 3M Scotchlite reflective film
Back side made of 100% polyester velvet fabric
Tested and certificated by TÜV Rheinland, Germany
Conforms to CE EN 13356



RADIATE TROUSERS CLIP

Made of ABS plastic material
3M Scotchlite reflective material



WINK KIDS SAFETY VEST

Made of 100% Polyester
Tested and certificated by TÜV Rheinland, Germany
Conforms to CE EN 13356



STARLIGHT KIDS SAFETY VEST

Made of 100% Polyester
Size adjustment by velcro straps
Tested and certificated by TUV Rheinland, Germany
Conforms to CE EN 1150
SIZES : XXS - M



MOONLIGHT ELASTIC SAFETY STRAP VEST

Universal size / uni-sex
Fully adjustable
Tested and certificated by TUV Rheinland, Germany
Conforms to CE EN 13356



TWINKLE SET LED SAFETY REFLECTOR WITH VELCRO CLIP

Made of high gloss 3M Scotchlite reflective film
Tested and certificated by TUV Rheinland, Germany
Conforms to CE EN 13356



TWINKLE PRO LED SAFETY REFLECTOR WITH MAGNETIC CLIP

Made of high gloss 3M Scotchlite reflective film
Tested and certificated by TUV Rheinland, Germany
Conforms to CE EN 13356



SPARKY PRO LED ARMBAND

Made of high gloss 3M Scotchlite reflective film
Tested and certificated by TUV Rheinland, Germany
Conforms to CE EN 13356





TRACK 30 WIRELESS CYCLE COMPUTER

22 FUNCTIONS:

- Clock (12/24Hr)
- Current Speed
- Average Speed
- Maximum speed
- Speed comparison up/down arrow
- Dual Wheel Size
- Trip Time
- Trip Distance
- Total Distance (ODO1 or ODO2)
- Total ODO (ODO1+ODO2)
- KCAL(Calories Consumption)
- Backlight
- Temperature
- Auto ON/OFF
- Daily Distance
- Low Battery Indicator
- Auto SCAN
- Actual Altitude
- Maximum Altitude
- Trip Climb
- Total Altitude (Altitude 1 & Altitude 2)
- Total Altitude (Altitude 1 + Altitude 2)

Big space LCD display offers easy read-out, including mounting bracket for handlebar and stem.

BATTERY: computer- 3V CR2032, Sensor-3V CR2032

COLORS: black, white

TRACK 10 WIRELESS CYCLE COMPUTER

14 FUNCTIONS:

- Clock (12/24Hr)
- Current Speed
- Average Speed
- Max Speed
- Speed comparison up/down arrow
- Dual Wheel Size
- Trip Time
- Trip Distance
- Total Distance (ODO1 or ODO2)
- Total ODO (ODO1+ODO2)
- KCAL(Calories Consumption)
- Backlight
- Temperature
- Auto ON/OFF

Big space LCD display offers easy read-out, including mounting bracket for handlebar and stem.

BATTERY: computer- 3V CR2032, Sensor-3V CR2032

COLORS: black, white



TRACK 50 WIRELESS CYCLE COMPUTER

22 FUNCTIONS:

- Clock (12/24Hr)
- Current Speed
- Average Speed
- Maximum speed
- Speed comparison up/down arrow
- Dual Wheel Size
- Trip Time
- Trip Distance
- Total Distance (ODO1 or ODO2)
- Total ODO (ODO1+ODO2)
- KCAL(Calories Consumption)
- Backlight
- Temperature
- Auto ON/OFF
- Daily Distance
- Low Battery Indicator
- Auto SCAN
- Current Heart Rate
- Average Heart Rate
- Maximum Heart Rate
- HR Arrow Show High/Low Limitation
- Heart Rate % of Max HR

For cycling enthusiasts who want to know if they're improving their cardio and burning calories. Big space LCD display offers easy read-out, including mounting bracket for handlebar and stem. Soft flexible chest belt provides highly accurate, wireless transmission of your heart rate to KLS Track 50. COMFORTABLE ADJUSTABLE STRAP FOR BETTER FIT.

BATTERY: computer- 3V CR2032, Sensor-3V CR2032, Chest belt unit- 3V CR2032

COLORS: black, white





RECKON WL WIRELESS CYCLE COMPUTER

10 FUNCTIONS:

- speedometer
- tripmeter (DST)
- odometer (ODO)
- auto trip timer (TM)
- maximum speed (MXS)
- digital clock
- average speed (AVS)
- scan of functions DST, MXS, AVS, TM
- speed comparator (+ / -)
- AUTOSTART

Double space LCD display offers easy read-out, click release system, single-piece sensor including MOUNTING BRACKET FOR HANDLEBAR.

BATTERY: computer- 3V CR2032, Sensor-3V CR2032

COLORS: black, white



RECKON WIRED CYCLE COMPUTER

10 FUNCTIONS:

- speedometer
- tripmeter (DST)
- odometer (ODO)
- auto trip timer (TM)
- maximum speed (MXS)
- digital clock
- average speed (AVS)
- scan of functions DST, MXS, AVS, TM
- speed comparator (+ / -)
- AUTOSTART

Double space LCD display offers easy read-out, click release system, single-piece sensor INCLUDING MOUNTING BRACKET FOR HANDLEBAR.

BATTERY: computer- 1,5V LR43

COLORS: black, white



DIGIT WIRED CYCLE COMPUTER

10 FUNCTIONS:

- speedometer
- tripmeter (DST)
- odometer (ODO)
- auto trip timer (TM)
- maximum speed (MXS)
- digital clock
- average speed (AVS)
- scan of functions DST, MXS, AVS, TM
- speed comparator (+ / -)
- AUTO-START STOP system

Double space LCD display offers easy read-out, click release system, single-piece sensor including mounting bracket for handlebar.

BATTERY: computer- 3V CR2032

COLOR: black



SCREENSHOT WIRED CYCLE COMPUTER

10 FUNCTIONS:

- speedometer
- tripmeter (DST)
- odometer (ODO)
- auto trip timer (TM)
- maximum speed (MXS)
- digital clock
- average speed (AVS)
- scan of functions DST, MXS, AVS, TM
- speed comparator (+ / -)
- AUTOSTART

Extra big double space LCD display offers easy read-out, click release system, single-piece sensor INCLUDING MOUNTING BRACKET FOR HANDLEBAR.

BATTERY: computer- 3V CR2032

COLOR: black



SCREENSHOT WL WIRELESS CYCLE COMPUTER

10 FUNCTIONS:

- speedometer
- tripmeter (DST)
- odometer (ODO)
- auto trip timer (TM)
- maximum speed (MXS)
- digital clock
- average speed (AVS)
- scan of functions DST, MXS, AVS, TM
- speed comparator (+ / -)
- AUTOSTART

Extra big double space LCD display offers easy read-out, click release system, single-piece sensor INCLUDING MOUNTING BRACKET FOR HANDLEBAR.

BATTERY: computer- 3V CR2032, sensor-3V CR2032

COLOR: black



REFLEX WIRELESS CYCLE COMPUTER

15 FUNCTIONS:

- speedometer
- tripmeter (DST)
- odometer (ODO)
- auto trip timer (TM)
- maximum speed (MXS)
- digital clock - 12/24 hour selectable
- average speed (AVS)
- scan of functions DST, MXS, AVS, TM
- speed comparator (+ / -)
- speed tendency (acceleration or deceleration)
- temperature
- calorie consumption
- total reduction of carbon dioxide emission
- AUTO-START STOP system
- backlight

Double space LCD display offers easy read-out, easy tool-less fixation to handlebar or stem by reorientation silicone unit.

Flexible silicone body, single-piece sensor.

BATTERY: Computer- 3V CR2032, Sensor-3V CR2032

COLORS: black, white, lime, turquoise.





MISSION:
THE THIRST KILLER





NAMIB WATER BOTTLE 0,7L

Original KLS design. Ultra-wide cap with rubber mouthpiece. Ultra-cap is easy to open, effortless to use, and leak-proof when closed. Made with BPA FREE technology for clean, pure refreshment. Suitable for water isotonic drinks, and other sport drinks without CO2 up to 60 °C

Made from BPA-free plastic
WEIGHT: 82g

COLORS: anthracite-white, anthracite-red, anthracite-orange, anthracite-turquoise, transparent-lime, transparent-blue, transparent-pink, transparent-black, fresh lime, fresh orange, fresh yellow, sky blue



ANTARCTICA WATER BOTTLE 0,65L/0,5L

Original KLS design. Double wall with airspace and special aluminum foil. Bottle ANTARCTICA is a soft, lightweight, easy-to-use insulated bottle that keeps beverages cool or warm. Ultra-wide cap with rubber mouthpiece. Ultra-cap is easy to open, effortless to use, and leak-proof when closed. Made with BPA FREE technology for clean, pure refreshment. Suitable for water isotonic drinks, and other sport drinks without CO2 up to 60 °C

Made from BPA-free plastic
WEIGHT: 0,65L-160g / 0,5L - 140g
COLORS: charcoal black, shiny white



GOBI WATER BOTTLE 0,5L

Original KLS design, Push pull cap with rubber mouthpiece, Made of high quality polyethylene, Suitable for water, isotonic drinks and other sport drinks without CO2 up to 40°C,

WEIGHT: 76g
COLORS: black-turquoise, white-lime, transparent grey-grey, red-white



TUNDRA THERMAL WATER BOTTLE 0,5L

Original KLS design, Double wall with airspace and alu foil, Push pull cap with rubber mouthpiece, Made of high quality polyethylene, Suitable for water, isotonic drinks and other sport drinks without CO2 up to 60°C,

WEIGHT: 131g
COLORS: white-red, black-grey, silver-yellow, white-lime



KALAHARI WATER BOTTLE 1L

Original Kellys design, Wide bottleneck for easy cleaning and filling, Soft lockable mouthpiece made of soft plastic BergaFlex™, Made of high quality polyethylene, Suitable for water, isotonic drinks and other sport drinks without CO2 up to 40°C,

WEIGHT: 117g
COLORS: semi-transparent anthracite-red, semi-transparent white-grey

KAROO WATER BOTTLE 0,7L

Original Kellys design, Push pull cap with rubber mouthpiece, Made of high quality polyethylene, Suitable for water, isotonic drinks and other sport drinks without CO2 up to 40°C,

WEIGHT: 87g
COLORS: black-red, silver-yellow, transparent-red, silver-turquoise

SPORT WATER BOTTLE 0,7L

Ergonomic shape and original design, wide bottle-neck for easy cleaning and filling, soft lockable mouthpiece from soft plastic BergaFlex™, made of high quality and proper hygienic, materials polypropylene Borealis / Mosten,

WEIGHT: 75g
COLORS: silver, semi-transparent white, red, semi-transparent anthracite



ATACAMA WATER BOTTLE 0,65L

Original KLS design. Made with BPA FREE technology for clean, pure refreshment. Rubber mouthpiece with dust cover. Mount peace is easy to open, effortless to use, and leak-proof when closed. Suitable for water isotonic drinks, and other sport drinks without CO2 up to 40 °C

Made from BPA-free plastic
WEIGHT: 80g
COLORS: black, orange, green, purple, tiffany blue

RANGIPO JUNIOR WATER BOTTLE 0,38L

Original KLS design fits children bikes. Made with BPA FREE technology for clean, pure refreshment. Childproof undetachable rubber mouthpiece to avoid suffocation. Mount peace is easy to open, effortless to use, and leak-proof when closed. Suitable for water isotonic drinks, and other sport drinks without CO2 up to 40 °C

Made from BPA-free plastic
WEIGHT: 60g
COLORS: blue, pink



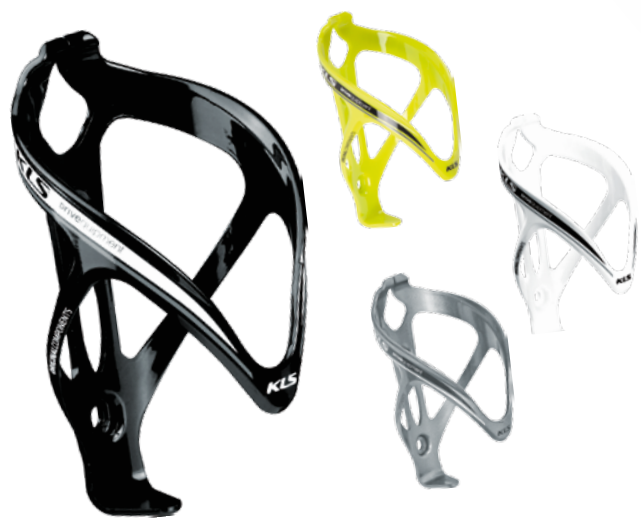

CURE NYLON BOTTLE CAGE

One piece nylon material
Including 2 stainless steel bolts
WEIGHT: 29g
COLORS: white, black, lime, grey



BULLET BOTTLE CAGE

Elastic tensioner for a secure bottle hold
Material aluminum alloy 5052
Including 2 stainless steel bolts
WEIGHT: 26g
COLORS: grey, white, lime



BALLISTIC BOTTLE CAGE

Side bottle cage for narrow bike frames
One piece nylon material
Including 2 stainless steel bolts
WEIGHT: 50g
COLORS: black, white



SIDEWINDER BOTTLE CAGE

Side bottle cage for narrow bike frames
Material aluminum alloy 6463-T5
Including 2 stainless steel bolts
WEIGHT: 35g
COLORS: black, white



SQUAD BOTTLE CAGE

Material plate aluminum alloy 6061-T5 press-molding
Including 2 stainless steel bolts
WEIGHT: 47g
COLORS: lime, blue, sky, green, orange, grey, white-grey

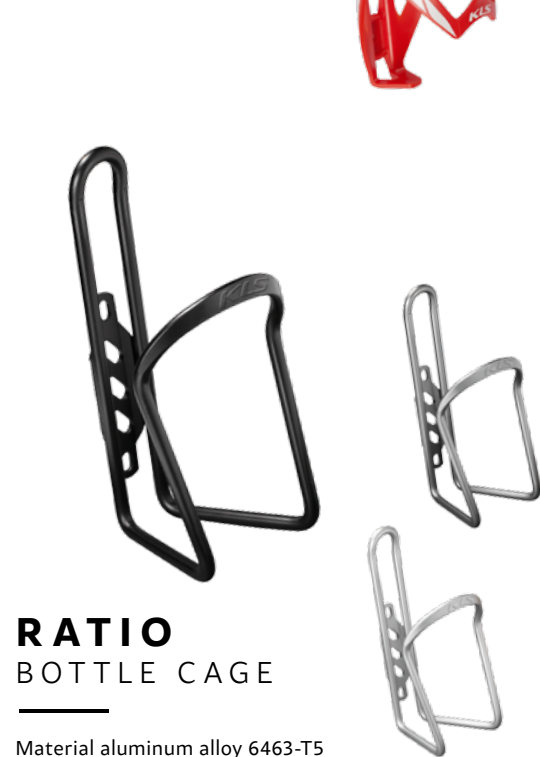

RATIO BOTTLE CAGE

Material aluminum alloy 6463-T5
Including 2 stainless steel bolts
WEIGHT: 59g
COLORS: black, grey, silver



PATRIOT BOTTLE CAGE

One piece polycarbonate material
Including 2 stainless steel bolts
WEIGHT: 33g
COLORS: red, black- blue, white,
black, lime, orange



CALIBER BOTTLE CAGE

Material aluminum alloy 6063 and nylon
Including 2 stainless steel bolts
WEIGHT: 40g
COLORS: black, grey, lime





THE SMART AND HANDY SOLUTION
TO ALWAYS KEEP YOU RIDING





AIRTANK FLOOR PUMP

Alloy service pump with Airtank
Inflates tubeless ready tires
Switchable Schrader/Presta
Ergonomic handle for comfortable pumping
Stable die-cast base covered by rubber for even better stability
Top mounted gauge

MAXIMUM PRESSURE:
240 psi/18 bar



AIRFLOW ONE FLOOR PUMP

Alloy Service pump
Large pressure gauge in base for easy reading
Ergonomic handle
Dual head for Schrader/Presta/Dunlop
Hose length: 940mm
Handle: 240 x 37mm

MAXIMUM PRESSURE:
160 psi/11 bar



MAGNUM FLOOR PUMP

Alloy floor pump
Pressure gauge
Dual head for Schrader/Presta/Dunlop
Ergonomic handle with rubber grip zones
Stable base

MAXIMUM PRESSURE:
160 psi/11 bar



TWISTER PRO FLOOR PUMP

Light weight plastic pump
Wider shaft for easy pumping
Dual head for Schrader/Presta/Dunlop
Wide base for stability
Half-height big round gauge

MAXIMUM PRESSURE:
160 psi/11 bar



TWISTER FLOOR PUMP

Light weight plastic pump
Wider shaft for easy pumping
Dual head for Schrader/Presta/Dunlop
Wide base for stability

MAXIMUM PRESSURE:
160 psi/11 bar



CLASSIC TRAVEL PUMP

Aluminium alloy pump
Combination of minipump with performance of floor pump
Hose ergonomically nested in oval
Reversible head for Schrader/Presta valve
Foldable T-handle
Integrated metal pedestal, including frame bracket
Weight: 209g

MAXIMUM PRESSURE:
120psi/8 bar

DRIFT MINIPUMP

CNC machined minipump
Patented auto switching dual head fits Schrader /Presta
Big barrel
Weight: 151g
Length: 215mm

MAXIMUM PRESSURE:
80psi/5 bar



OMNI MINIPUMP

All in one mini pump
Shock/Schrader/Presta/Dunlop
Multi-directional hose
Bleeder for fine tuning pressure
Gauge for Bar/PSI reading
High pressure – Big volume switch
Weight: 218g
Length: 260mm

MAXIMUM PRESSURE:
300 psi





DOUBLY PRO 50

ERGONOMIC ALLOY MINI PUMP

Dual head for Schrader/Presta/Dunlop
Telescopic
Ergonomic T-Lock handle
Weight: 153g
Length: 265mm
MAXIMUM PRESSURE: 100psi/7 bar



DOUBLY PRO 10

ERGONOMIC PLASTIC MINI PUMP

Dual head for Schrader/Presta/Dunlop
Telescopic
Ergonomic T-Lock handle
Weight: 128g
Length: 265mm
MAXIMUM PRESSURE: 100psi/7 bar



PULSE

MINIPUMP

Compact- lightweight - plastic body
Reversible Schrader/Presta
Thumb Lock system
Space in the handle for repair set or tools.
Including bracket
Length: 255mm
Weight: 130g
MAXIMUM PRESSURE: 80psi / 5 bar



DOUBLY PRO 30

ERGONOMIC ALLOY MINI PUMP

Dual head for Schrader/Presta/Dunlop
Ergonomic T-Lock handle
Weight: 137g
Length: 265mm
MAXIMUM PRESSURE: 80psi/5 bar



SHOCK PUMP

HIGH-PRESSURE PUMP

Alloy high pressure pump
With pressure gauge
Covered fine tuning pressure bleeding valve
Swivel hose for easy pumping
Ergonomic handle
Length: 260mm
Weight: 190g
MAXIMUM PRESSURE: 300 psi/20 bar



SHOCKER

HIGH-PRESSURE PUMP

With pressure gauge
Fine Tuning pressure bleeding valve
2-stage non-leakage valve
Swivel hose for easy pumping
Plastic upper & lower handles
Pinch-Free locked T-handle
Length: 260mm
Weight: 190g
MAXIMUM PRESSURE: 300 psi/20 bar





LION ALARM ALARM LOCK

dual functions: Alarm system and lock
1500mm cable for lock included.
mini USB charging cable included.
waterproof.
3 Keys included



FOLD FOLDING LOCK

3mm hardened steel
2 keys included
Bracket included
LENGTH: 830mm



TOUGH 50 FOLDING LOCK

5mm steel
2 keys included
bracket included
LENGTH: 780mm



TOUGH 30 FOLDING LOCK

3.5mm steel
2 keys included
bracket included
LENGTH: 850mm
COLORS: blue, green, grey



CHAINLOCK 10 STEEL CHAIN LOCK

10mm Shackle diameter
cylinder with anti-drill, anti-saw and anti-pick protection
improved nylon sleeve provides scratch protection
easy to place it under the saddle for transportation
corrosion protection



CHAINLOCK 8 STEEL CHAIN LOCK

8mm Shackle diameter.
Cylinder with anti-drill, anti-saw and anti-pick protection
improved nylon sleeve provides scratch protection
easy to place it under the saddle for transportation
corrosion protection



CHAINLOCK 6 COMBINATION STEEL CHAIN LOCK

6mm Shackle diameter
improved nylon sleeve provides scratch protection
easy to place it under the saddle for transportation
corrosion protection



CHAINLOCK 4 COMBINATION STEEL CHAIN LOCK

4mm Shackle diameter
improved nylon sleeve provides scratch protection
easy to place it under the saddle for transportation
corrosion protection





BLOCK STEEL U-LOCK

15mm steel
2 keys included
comes with a dustcap
anti-scratch cover
DIMENSIONS: 170 x 320mm



ALERT PLUS STEEL U-LOCK

12mm steel
2 keys included
bracket included
comes with a dustcap.
anti-scratch cover
DIMENSIONS: 165 x 245mm

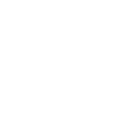

RECOIL SPIRAL CABLE LOCK

diameter of braided steel wire Ø5.6mm
outer diameter of lock-body Ø12mm
2 keys - one in normal version - the second one
with a luminous LED diode
bracket Included
LENGTHS: 1200mm, 1500mm,
1800mm (with bracket)



HARDCOIL SPIRAL CABLE LOCK

diameter of braided steel wire Ø7mm
outer diameter of lock-body Ø15mm
2 keys - one in normal version - the second one
with a luminous LED diode
bracket Included
LENGTHS: 1200mm, 1500mm, 1800mm



COIL SPIRAL CABLE LOCK

diameter of braided steel wire Ø4.5mm
outer diameter of lock-body Ø10mm
2 keys - one in normal version - the second one
with a luminous LED diode
bracket Included
LENGTHS: 1200mm, 1500mm, 1800mm (with bracket)



CRYPT COMBINATION SPIRAL CABLE LOCK

combination lock with light
precision lock cylinder with tamper-proof and
anit-pick protection
special safety light feature
LENGTH: 800mm
COLORS: black, lime, orange, blue



ENCODE COMBINATION SPIRAL CABLE LOCK

diameter of braided steel wire Ø5.6mm
outer diameter of lock-body Ø12mm
re-settable PIN code, with the seatpost bracket
LENGTH: 1000mm



CODE COMBINATION SPIRAL CABLE LOCK

diameter of braided steel wire Ø3.8mm
outer diameter of lock-body Ø8mm
LENGTH: 1000mm



JOLLY CABLE LOCK COVERED BY SOFT RUBBER

Inner braided wire Ø4,5 cm
outer diameter Ø12 cm
LENGTH: 65 cm
COLORS : black, sky, lime, red



BILL SPIRAL CABLE LOCK

outer diameter of lock-body Ø6mm
2 keys, including bracket
LENGTHS: 800mm



CABLE EXTENSION CABLE

Diameter of braided steel wire Ø5.6mm
Outer diameter of lock body Ø12mm
Extends U-Lock's protection to all part of bike.
LENGTH: 2000mm





MISSION:
THE TRAIL EXPLORER





DANDY SADDLE BAG

Made of 600D polyester/420D nylon ripstop
3M reflective stripe
Safety light attachment
Patented T-system toolfree attachment
L size extendable

SIZES:

DANDY T-SYSTEM S

volume 0,5l, dimensions (14,5cm x 8,5cm x 7,5cm)

DANDY T-SYSTEM L

volume 1,1+0,3l dimensions (17cm x 10,5cm x 11cm)



T-system TOOLFREE



SLOPPER SADDLE BAG

Made of 600D polyester/420D nylon ripstop
3M reflective stripe
Safety light attachment
Patented T-system toolfree attachment

SIZES:

SLOPPER T-SYSTEM S

volume 0,4l, dimensions (17cm x 8cm x 10cm)

SLOPPER T-SYSTEM M

volume 0,7l dimensions (20cm x 8,5cm x 10,5cm)



T-system TOOLFREE



T-system TOOLFREE

CHALLENGER SADDLE BAG

Made of 600D polyester/Poly honeycomb/Tarpaulin
3M reflective stripe
Safety light attachment
Patented T-system toolfree attachment/Velcro strap attachment

SIZES:

CHALLENGER T-SYSTEM/STRAP S

volume 0,4l, dimensions (17cm x 7cm x 8,5cm)

CHALLENGER T-SYSTEM/STRAP M

volume 0,6l (19cm x 8cm x 9,5cm)

CHALLENGER T-SYSTEM/STRAP L

volume 0,9l (21,5cm x 9,5cm x 9,5cm)



SPACE 10 REAR PANNIER BAG

Made of 600D polyester/Poly honeycomb/PVC leather/Nylon 210D
Two side pockets
Inside mesh pocket
Rubber band on the top of the bag
3M reflective piping
Safety light attachment
Velcro strap fastening
Detachable shoulder strap

VOLUME 10l

DIMENSIONS: 35cm x 18cm x 22cm



ADVENTURE 40 REAR PANNIER BAG

Made of 600D polyester/Poly honeycomb/Nylon 210D
Two main compartments with two side pockets
Two rear zipped pockets
3M reflective piping

Fastening on rear carrier by straps and hooks

Waterproof raincover in lime colour with taped seams included in bottom pocket.

VOLUME 40l

DIMENSIONS: 32cm x 20cm x 40cm (one side)



SPACE 15 REAR PANNIER BAG

Made of 600D polyester/Poly honeycomb/Nylon 210D
Extendable 2 side pockets
Inside mesh pocket
Rubber band on the top of the bag
3M reflective piping
Safety light attachment
Velcro strap fastening
Detachable shoulder strap

VOLUME 15l

DIMENSIONS: 32,5cm x 28cm x 19cm



ADVENTURE 20 REAR PANNIER BAG

Made of 600D polyester/Poly honeycomb/Nylon 210D
Two main compartments with two smaller side pockets
Rubber band on the top of the bag
3M reflective piping

Fastening on rear carrier by straps and hooks

VOLUME 20l

DIMENSIONS: 33cm x 10cm x 28cm (one side)



SPACE CITY REAR PANNIER BAG

Made of 600D polyester/Nylon 210D
Two side pockets
Inside mesh pocket
Adjustable inside sections
3M reflective piping
Safety light attachment
Velcro strap fastening
Carrying strap

VOLUME 10l

DIMENSIONS: 31cm x 16cm x 20cm





CELLY TOP TUBE BAG

Made of 600D polyester/ Poly honeycomb/Nylon 210D
Transparent top part keep smartphone up to 5,5 inch display
3M reflective piping
Velcro strap fastening
VOLUME 0,7l
DIMMENSIONS: 10cm x 18cm x 9cm



WEDGE FRAME BAG

Made of 600D polyester/ Poly honeycomb/Nylon 210D
3M reflective piping
Inner compartment with small mesh pocket
Adjustable Velcro strap fastening
VOLUME 0,9l



RECTANGLE FRAME BAG

Made of 600D polyester/ Poly honeycomb/
Nylon 210D
3M reflective piping
Velcro strap fastening
VOLUME 1,3l
DIMMENSIONS: 12cm x 27cm x 5cm



ALPHA TOP TUBE BAG

Made of 600D polyester/Poly honeycomb/Nylon 210D
Two side pockets with small inner section
Transparent top part keep smartphone up to 5,5 inch display
3M reflective piping
Velcro strap fastening
VOLUME 0,9l
DIMMENSIONS: 14,5cm x 13cm x 11cm



SATELLITE SEAT POST BAG

Made of EVA foam/600D polyester/Poly honeycomb
Inside section can be divided to two parts
Zipped mesh pocket
3M reflective piping
Safety light attachment
Quick release system fits all sizes
Maximum carrying load: 4kg
VOLUME 3,2l
DIMMENSIONS: 31cm x 16cm x 15cm



TANK 20 WATER BLADDER

Made of PEVA
Wide opening Slide lock system for easy and
comfort filling and cleaning
Detachable 100cm PVC tube with valve water
lock system
Neoprene sleeve on PVC tube included
VOLUME 2l



LEAD HANDLEBAR BAG

Made of 600D polyester/Poly honeycomb/PVC leather/Nylon 210D
Top transparent pocket for map or smartphone
2 mesh pockets and one front pocket
3M reflective piping
Shoulder strap included
Safety light attachment
Quick release system fits oversized handlebars
VOLUME 4l
DIMMENSIONS: 25,5cm x 14,5cm x 12cm



TANK 30 WATER BLADDER

Made of PEVA
Wide opening Slide lock system for easy and comfort filling and cleaning
Detachable 100cm PVC tube with valve water lock system
Neoprene sleeve on PVC tube included
VOLUME 3l





KEEP YOUR STYLE NICELY PACKED





CARGO FRONT BASKET

High quality front steel basket
Very handy for shopping
Quick release bracket
Click" bracket, easy to mount, with swing up handle
Fits for handlebars: 22,2mm - 25,4mm- 31.8mm
SIZE: 340x250x250mm
Carries up to 5kg

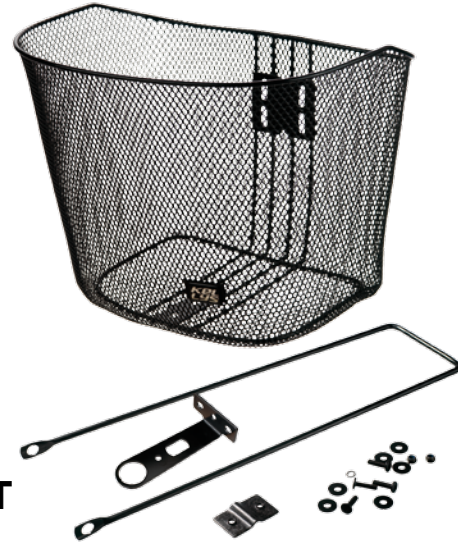

CITY FRONT FRONT BASKET

front steel basket with brace and grip under the headset nut
Easy to mount
SIZE: 350x255x260mm (W x L x H)
Carries up to 5kg

CITY REAR REAR BASKET

Black steel basket
Fixed mounting lengthwise on luggage carrier
(including fixing material)
SIZE: 290x400x180mm
Carries up to 5kg

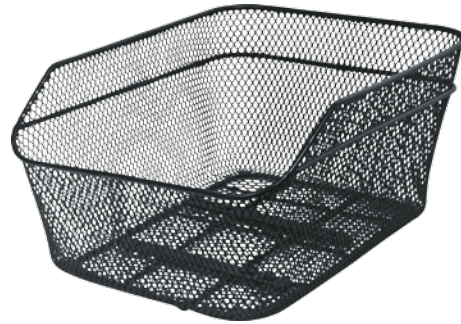

RATTAN REAR REAR BASKET

High quality plastic rattan basket
Mounting with cable ties (including 6Pcs)
SIZE: 300x410x190mm
Carries up to 5kg

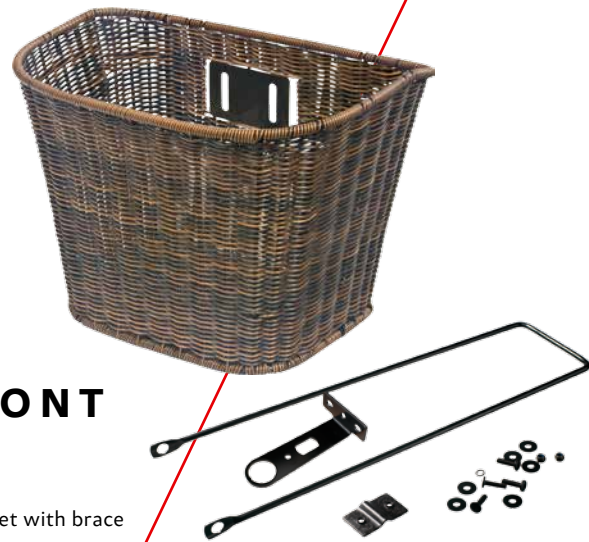

RATTAN FRONT FRONT BASKET

High quality plastic rattan basket with brace
and grip under the headset nut
Easy to mount
SIZE: 350x260x250mm (W x L x H)
Carries up to 5kg



PORTER BICYCLE RACK

Ø25,4 – 32mm
Quick release TOOLFREE bracket
Material aluminum alloy
Rubber pad for a better grip and seat post
protection
Max load 10kg
Bracket for lights or reflector

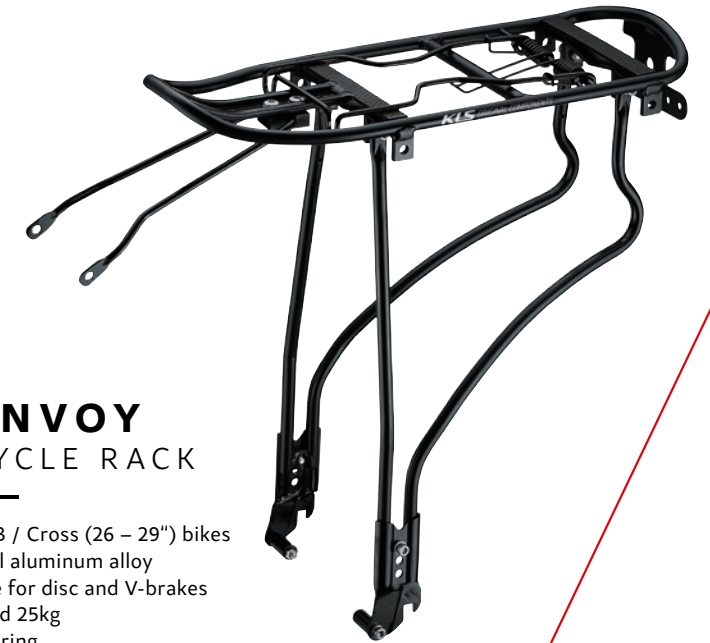

CONVOY BICYCLE RACK

For MTB / Cross (26 – 29") bikes
Material aluminum alloy
Suitable for disc and V-brakes
Max load 25kg
With spring
Bracket for lights or reflector





KNIGHT MUDGUARD SET

front and rear mudguard
front mudguard with Turner system - Two position quick release system
rear mudguard with SQR System - Smart Quick Release System.
QR system for all seat posts diameters
rear mudguard holder with two joints and an adjustable angle



THUNDER MUDGUARD SET

front and rear mudguard
rear mudguard holder with two joints and an adjustable angle
simple and quick mounting



FUSE MUDGUARD SET

front and rear mudguard
including two clamp diameters for all frame types
adjustable rear mudguard holder



SHIELD R MUDGUARD

rear mudguard
rear mudguard with SQR System – Smart Quick Release System.
QR system for all seat posts diameters
mudguard holder with an adjustable angle
AVAILABLE IN TWO SIZES:
26" - 27,5" wheel size
27,5 -29" wheel size

SHIELD F MUDGUARD

front mudguard
suitable for all types of frame tubes
fixation by flexible mounting straps
simple mounting on the downtube
AVAILABLE IN TWO SIZES:
26" - 27,5" wheel size
27,5 -29" wheel size





GUARD MUDGUARD SET

Front and rear mudguard for MTB and Cross
Increased protection for front derailleur
Excellent protection on wet or muddy terrain



STORM MUDGUARD SET

Front and rear mudguard for MTB and Cross
Two ways of mounting on the seat tube:
1. Fixation by adjustable mudguard bracket
2. Fixation by flexible mounting strap
Suitable for all frame types



RAINY MUDGUARD SET

Front and rear mudguard for Cross and Trekking bikes with metal stays
Excellent protection on wet or muddy terrain
Fixation material included
Easy to fit
COLORS: black, grey, white



FOGGY MUDGUARD SET

Front and rear mudguard for children bikes
Suitable for 20" wheels
Fixation material included
Easy to fit
COLORS: black-grey, black-green, black-blue, white-pink, white-grey



IMPACT HILL MUDGUARD

Universal FRONT or REAR mudguard with pre-cut holes for cable ties
FRONT mudguard stopping the mud and dirt that's thrown into your eyes from the front wheel, also give additional protection to your fork seals.
REAR mudguard protecting your suspension system (linkages, bearings, joints) and shock from getting dirty
Suitable for forks from 80mm to 200mm travel, fits 26", 27,5" and 29" wheel size.





DOUBLEKICK KICKSTAND

For City / MTB / Cross (24 – 28") bikes
Two legs for increased stability
Rubber pads for a better grip and frame protection
INBUS adjustable



KICKUP KICKSTAND

For City / MTB / Cross (24 – 29") bikes
Rubber pads for a better grip and frame protection
TOOLFREE adjustable



KICKER KICKSTAND

For MTB / Cross (26 - 28") bikes
Rubber pads for a better grip and frame protection
TOOLFREE adjustable



KICKFLIP KICKSTAND

For City / MTB / Cross (24 – 28") bikes
For chain stays with fixed plate (40mm width of holes)
Rubber pads for a better grip and frame protection
TOOLFREE adjustable



KICKDOWN KICKSTAND

For City / MTB / Cross (24"-29") bikes
Plastic pads for a better grip and frame protection
TOOLFREE adjustable



KICKBACK KICKSTAND

For MTB / Cross (26 - 28") bikes
Rubber pads for a better grip and frame protection
TOOLFREE adjustable



KICKSTART KICKSTAND

For Junior / City (14"-20") bikes
Rubber pads for a better grip and frame protection
TOOLFREE adjustable



SENTRY CHAIN STAY PROTECTOR

Flexible neoprene cover to prevent chain stay damage
Velcro strap for easy installation

SIZE: M (255 x 110 mm)
COLORS: grey, lime, orange, blue,

SIZE: L (255 x 130 mm)
COLORS: grey

SIZE: Trapezium (Size: 255 x 130mm / 255 x 110mm)
COLORS: grey





BANG 10

Lightweight bicycle bell with extra loud stainless top and steel spring
Easy to install and remove
Mountable in various positions
360 degrees turnable
With metric screw
COLORS: black, silver



BANG 30

Lightweight bicycle bell
Alloy top with plastic base and lever
Quick release – easy to install and remove
Top size: 32mm
COLOR: black



BANG 50

Lightweight bicycle mini bell with shrill sound
Easy to install and remove
Mountable in various positions
360 degree turnable
With metric screw
Top size: 23mm
COLORS: gold, black

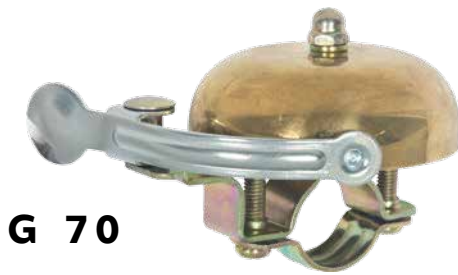

BANG 70

High end brass bell with resonant sound
Easy to install and remove
With metric screws
Top size: 50mm
COLORS: brass



BELL 20

Lightweight bicycle bell with ringing sound
Alloy top with plastic base and lever
Easy to install and remove
With metric screw
Top size: 53mm
COLORS: black, silver



BELL 60

Big bicycle bell with ding dong sound
Steel top and base
Easy to install and remove
With metric screws
Top size: 60mm
COLORS: gold, silver, red lips, white flowers



BELL 80

Big bicycle bell with ding dong sound
Steel top and base
Easy to install and remove
With metric screws
Top size: 80mm
COLORS: red dots, black dots, colorful dots, silver



STYX SADDLE

Made for Enduro Adventures
Zone cut releases pressure in most sensitive area
Hi-Density foam
Scale for precise adjustment
SIZE: 277 x 162mm
COLOR: Yellow, Orange, Green, Blue, Black

FLUO SADDLE

Saddle made for your daily training
Sport design combined with extra comfort
Hi-Density foam
Scale for precise adjustment
SIZE: 270 x 125mm
COLOR: Grey



DIVERSA SADDLE

Designed to perfectly fit woman ergonomics
For everyday bike ride anywhere
Hole releases pressure in most sensitive area
Hi-Density foam
Scale for precise adjustment
SIZE: 274 x 158mm
COLOR: Black, White





DRIVELINE SADDLE

Designed for daily MTB adventures
Zone cut releases pressure in most sensitive area
Hi-Density foam
Scale for precise adjustment
SIZE: 277 x 162mm
COLOR: Red, Green, Blue, Orange, Black



CROSSLINE SADDLE

Designed for Cross-Country adventures
Side protection ensures longer durability
Zone cut releases pressure in most sensitive area
Hi-Density foam
Scale for precise adjustment
SIZE: 262 x 175mm
COLOR: Red, Green, Blue, Orange, Black



TIMBER SADDLE

Gel combined with Hi-Density foam
Side protection ensures longer durability
Scale for precise adjustment
For everyday bike ride anywhere
SIZE: 275 x 163mm
COLOR: Black



COMFORTLINE SADDLE

Made to ensure maximum comfort
Zone cut releases pressure in most sensitive area
Hi-Density foam
Scale for precise adjustment
SIZE: 277 x 162mm
COLOR: Red, Green, Blue, Orange, Black



SOFTLINE SADDLE

Gel combined with high density foam
Side protection ensures longer durability
Scale for precise adjustment
For everyday bike ride anywhere
SIZE: 257 x 187mm
COLOR: Black



VAN KELLYS SADDLE

High density gelly foam
Steel spring for comfort suspension
Scale for precise adjustment
Designed to cruise your city
SIZE: 250 x 210mm
COLOR: Brown, Black

DRIVELINE JUNIOR SADDLE

Designed for everyday bike ride anywhere
Made to ensure maximum comfort
Hi-Density foam
Scale for precise adjustment
SIZE: 275 x 163mm
COLOR: Grey



CITYRIDE SADDLE

Gel combined with high density foam
Elastomer shock absorber system
Scale for precise adjustment
Designed for everyday urban ride
SIZE: 260 x 225mm
COLOR: Black





We would like to introduce the new groupsets of KLS bicycle cockpit components. According to the purpose and technical advancement our handle bars, stems and seat posts are set into four groups: ULTIMATE, ADVANCED, ACTIVE and CROSS. Just choose the best group for yourself and enjoy high quality components which fit your individual needs.

ULTIMATE

The ULTIMATE is a group which represents components of the highest quality, designed for the most ambitious and demanding cyclists. Thanks to the highest quality materials and modern manufacturing technologies, these components provide the ULTIMATE performance and lightness for riders who do not accept any compromises.

ADVANCED

Components from the ADVANCED group combine excellent performance and quality materials with the reasonable price. It is an excellent choice for ADVANCED riders looking for optimal solutions with a racing capabilities.

ACTIVE

The ACTIVE group is the best choice for riders who are looking for durable components with a great design at an affordable price. The reliability is number one priority, so every rider can stay ACTIVE in every situation.

CROSS

The CROSS line is dedicated to riders who value comfort and reliability when driving long distances. The special design allows optimal fit and reliability for CROSS and trekking enthusiasts.

AL 7050 – Strongest aluminum alloy, commonly used in rock-climbing equipment, hang glider frames, military, automotive and, of course, bicycle industry. Toughest material, but difficult to weld. That's why it is used mostly for Handle Bars only.

AL 6061 – Aluminum alloy commonly used in home build or hobby aircraft, yacht constructions or scuba tanks. Provides very good ratio between strength and affordability.

DOUBLE BUTTED – 2 thicknesses of material are combined to provide best of both – strength and lightweight. Where the material needs to stand against strong pressure, it is thickened to provide extra strength. On points where the material is not handling that much pressure, it is thinned to reduce unnecessary weight.

T6 – process of increasing the material hardness by heating the material to a certain temperature for certain period of time. Times and temperatures may vary based on materials used. This process arranges atoms in molecular structures which greatly increase the strength of material. Also called "Aging Process"

3D FORGING – Solid block of heated aluminum is compressed into desired mould. Advantage of this technology of forging is that no welding needs to be used, so the component is lighter and stronger in the end.



ULTIMATE RISEBAR, HANDLEBAR

Rise 15mm
Back sweep 5° / up sweep 4°
Width: 680mm
Diameter: 31.8mm O/S
FINISH: sand blasted black



ULTIMATE FLATBAR, HANDLEBAR

Back sweep 5°
Width: 720mm
Diameter: 31.8mm O/S
FINISH: sand blasted black

ULTIMATE SEAT POST

One-piece aluminum head
Diameter: 27.2, 30.9, 31.6mm
Length: 400mm
FINISH: sand blasted black



ULTIMATE STEM

Angle 7°
Diameter: 31.8mm O/S
Extension: 90, 100, 110, 120, 130mm
Steerer tube diameter: 28.6mm
FINISH: sand blasted black





ADVANCED RISEBAR, HANDLEBAR

Rise 15mm
Back sweep 5° / up sweep 4°
Width: 720mm
Diameter: 31.8mm O/S
FINISH: sand blasted black



ADVANCED FLATBAR, HANDLEBAR

Back sweep 5°
Width: 720mm
Diameter: 31.8mm O/S
FINISH: sand blasted black



ADVANCED STEM

Angle 7°
Diameter: 31.8mm O/S
Extension: 90, 100, 110, 120, 130mm
Steerer tube diameter: 28.6mm
FINISH: sand blasted black



ADVANCED SEAT POST

Forged head
Diameter: 27.2, 30.9, 31.6mm
Length: 400mm
FINISH: sand blasted black, white



ACTIVE RISEBAR, HANDLEBAR

Rise 15mm
Back sweep 5° / up sweep 4°
Width: 720mm
Diameter: 31.8mm O/S
FINISH: sand blasted black



ACTIVE FLATBAR, HANDLEBAR

Back sweep 5°
Width: 720mm
Diameter: 31.8mm O/S
FINISH: sand blasted black



ACTIVE STEM

Angle 7°
Diameter: 31.8mm O/S
Extension: 90, 100, 110, 120, 130mm
Steerer tube diameter: 28.6mm
FINISH: sand blasted black



ACTIVE SEAT POST

Die casted clamps
Diameter: 27.2, 30.9, 31.6mm
Length: 400mm
FINISH: sand blasted black



CROSS RISEBAR, HANDLEBAR

Rise 30mm
Back sweep 9° / up sweep 0°
Width: 640mm
Diameter: 25.4mm
FINISH: sand blasted black



CROSS STEM

Angle 7°
Diameter: 31.8mm (95, 110, 125mm)
Diameter: 25.4mm (90, 110, 125mm)
Steerer tube diameter: 28.6mm
FINISH: sand blasted black



CROSS GROUP

ADVANCED GROUP



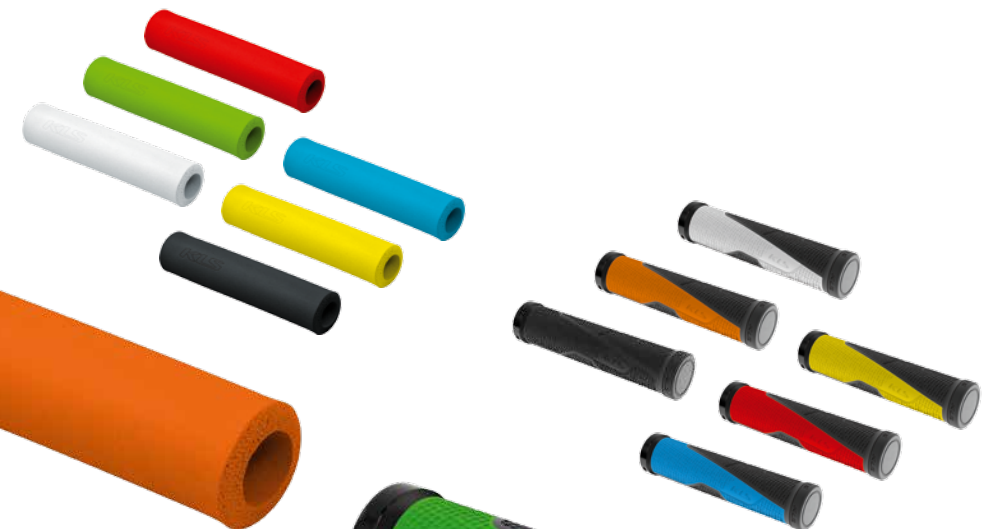

SILICA GRIPS

Silicone grips made for absolute comfort
Excellent performance – wet or dry
Width: 130mm
COLOR: Red, Green, Blue, Yellow, Orange, White, Black

CRYPTON GRIPS

Single LockOn for slip-free performance and easy mounting
2 density kraton rubber for soft touch and shock absorption
Designed for tight grip and ultimate ride control
Width: 135mm
COLOR: Red, Green, Blue, Yellow, Orange, White, Black



ADVANCER GRIPS

2density kraton rubber for soft touch and shock absorption
Designed for tight grip and ultimate drive control
Width: 130mm
COLOR: Red, Green, Blue, Yellow, Orange, White, Black



TOKEN GRIPS

Semi ergo shape
Combines comfort of ergo grip yet can handle rough MTB terrain
Single-lockring version for slip-free performance and easy mounting available
2 density kraton rubber for soft touch and shock absorption
Width 130/135mm
COLOR: Red, Green, Blue, Yellow, Orange, White, Black



POISON GRIPS

2 alloy lock rings for slip-free performance and easy mounting
Extra soft materials for extra comfort
Rough design for tight grip and ultimate ride control
Plastic plugs included
Width: 135mm
COLOR: Red, Green, Blue, Yellow, Orange, White, Black





WAVE GRIPS

Ergonomic shape ensure maximum comfort
2 density kraton rubber for soft touch and shock absorption
Width 130/135mm
Plastic plugs included
COLOR: Grey



FOAM GRIPS

High density foam handle
Plastic plugs included
Width: 130mm
COLOR: Black



SHORTGRIP GRIPS

Kraton rubber absorbs vibration
Designed for Twist-Grip systems
Width: 90mm
COLOR: Black

HOLLANDGRIP GRIPS

Ergonomic Shape
Designed for stylish ride through your city
Provides excellent grip with optimal control
Plastic plugs included
Width: 132, 132/92 mm
COLOR: Brown, Black

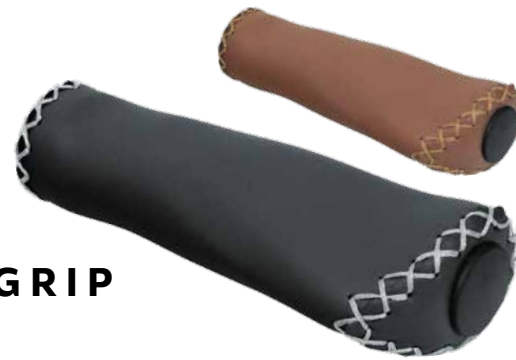

KIDDO' GRIPS

Slip protection helps your youngest to keep hands on handlebars at all times
Designed to fall in love with instantly
Width: 95mm
COLOR: Red, Green, Blue, Yellow, Pink, Purple, White, Black

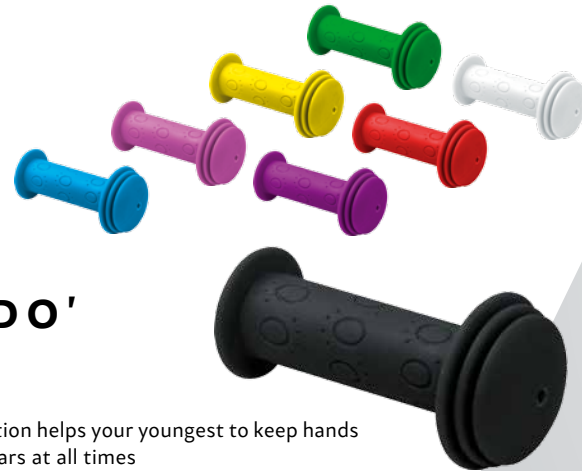

FOAM LOCK-ON GRIPS

High density foam ergonomic handle
Single LockOn for slip-free performance and easy mounting
Plastic plugs included
Width: 130mm
COLOR: Black



WRAPPER HANDLEBAR TAPE

Standard EVA tape (Ethylene Vinyl Acetate) with adhesive gel back for shock absorption
Soft touch brushed surface for comfort grip
Lightweight and good flex for easy wrapping
Including end-plugs and end tape
COLOR: black, white, black-red, black-blue



TREX BAR ENDS

Ergonomic shape
One piece 6061-T6 aluminum alloy
Length: 90mm
FINISH: White, Sand Blasted Black



RACE BAR ENDS

Ergonomic shape
One piece 6061 aluminum alloy
Length: 115mm
FINISH: Black



GRIPPY BAR ENDS

Kraton rubber for soft touch and shock absorption
Plastic body with alloy lock ring rims for slip-free performance and easy mounting
Ergonomic shape
Length: 85mm
FINISH: Sand Blasted Black



ADVANCED BAR ENDS

Ergonomic shape
One piece 6061-T6 aluminum alloy
Length: 110mm
FINISH: Sand Blasted Black



CROSS BAR ENDS

Ergonomic shape
One piece 6061 aluminum alloy
Length: 160mm
FINISH: Sand Blasted Black



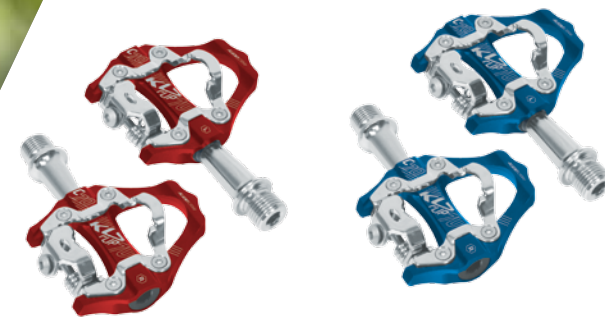

CLIP 70

Aluminum SPD Compatible pedal for Road/MTB
One side SPD Cleat
Body: Aluminum, CNC-machined body
Axle: CNC Machined Cr-Mo
Bearing: LSL Bushing and Sealed
SIZE: 83 x 71mm
WEIGHT: 270g

CLIP 50

SPD Compatible pedal for MTB
One side SPD cleat, stable platform on the other.
Body: Plastic
Bearing: LSL Bushing & Sealed
Axle: CNC Machine Cr-Mo
SIZE: 100 x 95mm
WEIGHT: 334g



CNC MACHINED
AL6061 CRMo

CLIP 90

SPD Compatible pedal for MTB
One side SPD Cleat, stable platform with grip pins on the other.
Body: Aluminum, CNC-machined body
Axle: CNC-machined Cr-Mo
Bearing: LSL Bushing & Sealed
SIZE: 88 x 86mm
WEIGHT: 300g

CLIP 30

Aluminum SPD Compatible pedal for MTB
One side SPD cleat, stable platform on the other.
Body: Aluminum
Axle: Cr-Mo
Bearing: Sealed
SIZE: 98 x 63mm
WEIGHT: 322g



CLIP 10

Aluminum SPD Compatible pedal for MTB
One side SPD cleat, stable platform on the other.
Body: Aluminum
Axle: Cr-Mo
Bearing: Sealed
SIZE: 103 x 63mm



RAPID

Aluminum Keo System compatible pedal for Road
 Body: Die-cast aluminum
 Axle: CNC-machined Cr-Mo
 Bearing: LSL Bushing and Sealed
SIZE: 86 x 86mm
WEIGHT: 330g

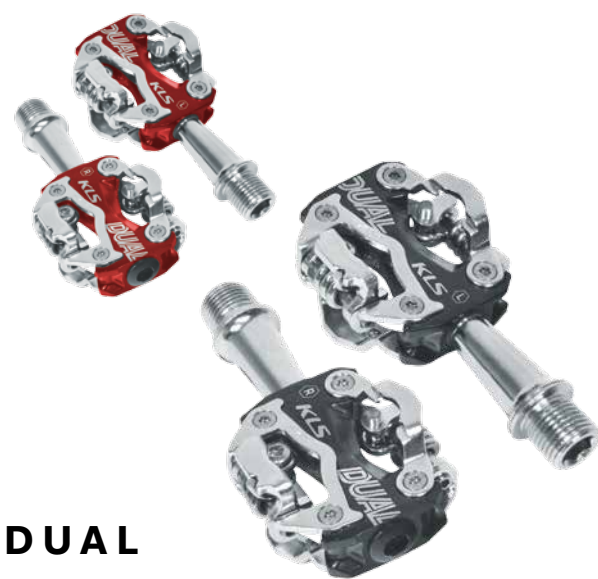

DUAL

Aluminum SPD compatible pedal for Road/MTB
 Two side SPD cleat
 Body: Aluminum
 Axle: Cr-Mo
 Bearing: Sleeved
SIZE: 80 x 49mm
WEIGHT: 260g



STEALTH

Platform pedal with a concave body
 CNC machined pedal made of 6082 aluminium alloy
 Thru Pins
 User maintainable
 Supplied with 2 full sets of pins, 8mm and 10mm
 Body: CNC aluminum
 Axle: CNC-machined Cr-Mo
 Bearing: Sealed cartridge bearings
SIZE: 105 x 110mm
WEIGHT: 390g



TRAIL 30

Aluminium pedal for Cross/City
 Body: Aluminium with non-slip rubber surface
 Axle: Boron
 Bearing: Ball bearings
SIZE: 108 x 84mm
WEIGHT: 390g



FLAT 10

Plastic pedal for BMX/City
 Body: Plastic
 Axle: Boron
 Bearing: Ball bearing
SIZE: 110 x 104mm
WEIGHT: 320g



FLAT 50

Aluminum pedal for BMX/MTB
 Pins: Replaceable grip pins and extra pins included.
 Axle: CNC-machined Cr-Mo
 Body: Die-cast aluminum
 Bearing: LSL Bushing & Sealed
SIZE: 115 x 108mm
WEIGHT: 550g

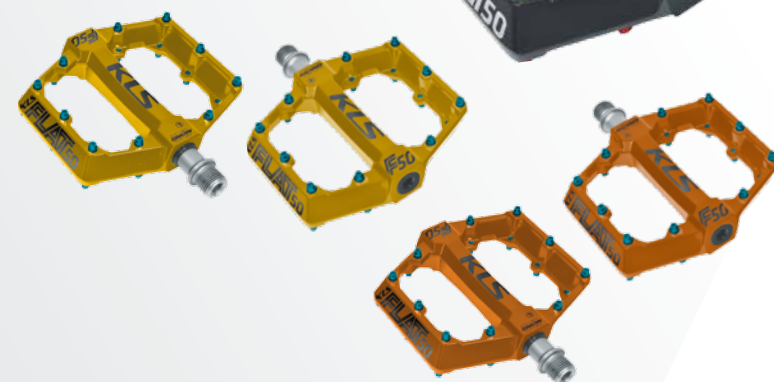

FLAT 50 BB

Aluminum pedal for BMX/MTB
 Pins: Replaceable grip pins and extra pins included.
 Axle: Boron steel
 Body: Die-cast aluminum
 Bearing: Ball bearings
SIZE: 115 x 108mm
WEIGHT: 550g



TRAIL 10

Plastic pedal for City/Cross
 Body: Plastic
 Axle: Boron
 Bearing: Ball bearing
SIZE: 109 x 75mm
WEIGHT: 384g



MASTER

Aluminium pedal for MTB/Cross
 Body: Aluminium
 Axle: Cr-Mo
 Bearing: Ball bearing
SIZE: 95 x 78mm
WEIGHT: 264g





SERVICE AND CARE

Maintenance and care of the bicycle are important elements of biking. Thanks to KLS service accessories every rider can do it on his own using smart and simple KLS tools, quality lubricants and effective cleaners to keep the bike in the best shape. Become a bicycle mechanic!





QUALITY

To service quality bikes the quality parts are needed. KLS spare parts, tools, lubricants and cleaners meet the highest requirements of Kellys bicycles. Using KLS products ensures trouble-free and safe riding for every biker.

RESPONSIBLY DESIGNED

KLS service equipment is both rider- and eco-friendly to ensure ease of use and prevent from leaving any environmental footprint.

PRACTICALITY

KLS service equipment is designed to be robust, easy to use and to fulfill even the most difficult tasks. KLS tools, lubricants and cleaners contain great capabilities in the simplest possible form.

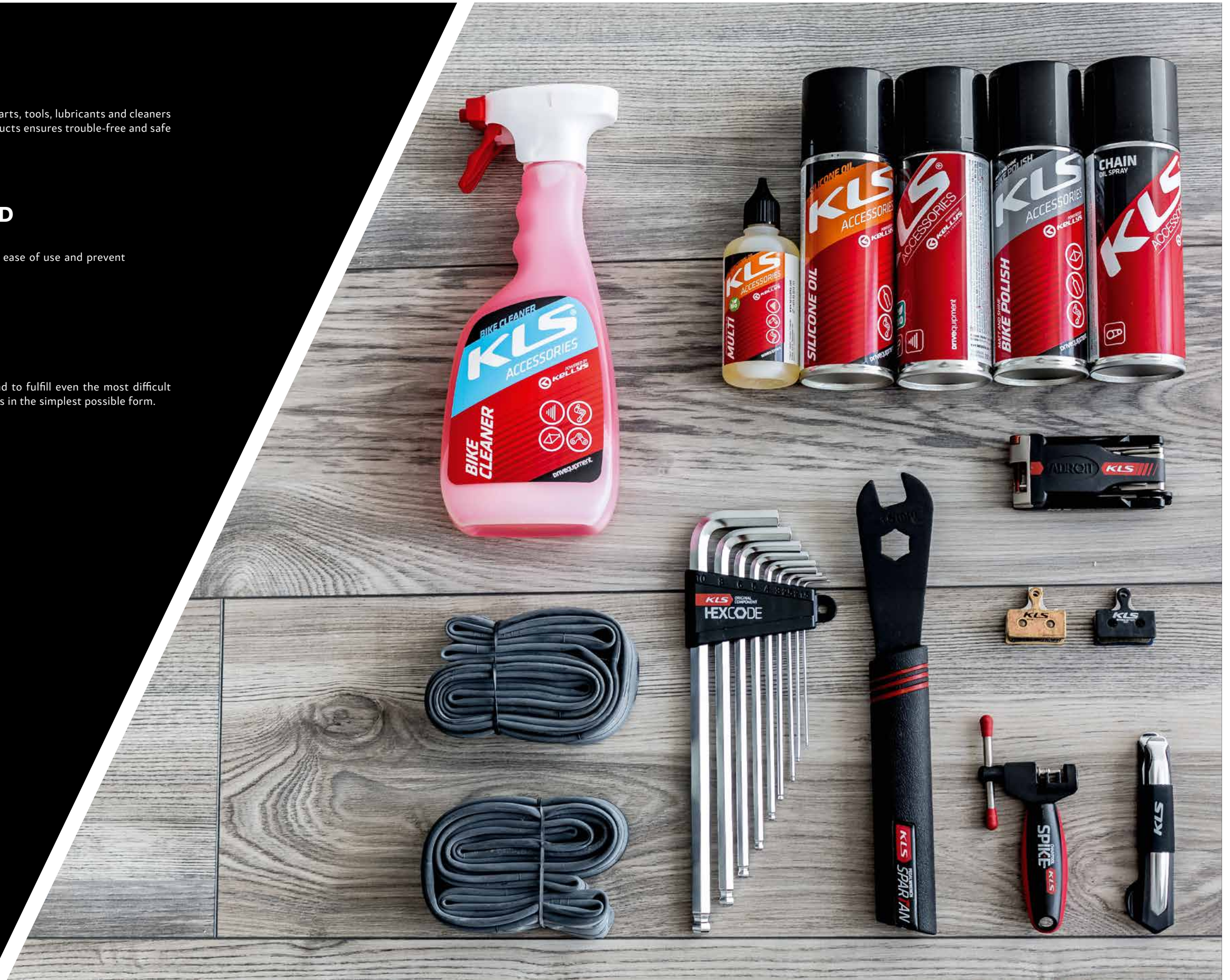



ADROIT FOLDING TOOL

Compact minitool with chain tool
Hardened chromevanadium steel (Cr-V) keys
19-functions, includes:

chain tool with chain hook	tire levers	2mm hex	2.5mm hex	3mm hex
4mm hex	5mm hex	6mm hex	8mm hex	box wrench 8mm
box wrench 9mm	box wrench 10mm	Torx 25		
philips head screwdriver	flat head screwdriver	spoke wrench 3.2 / 3.3 / 3.5mm		

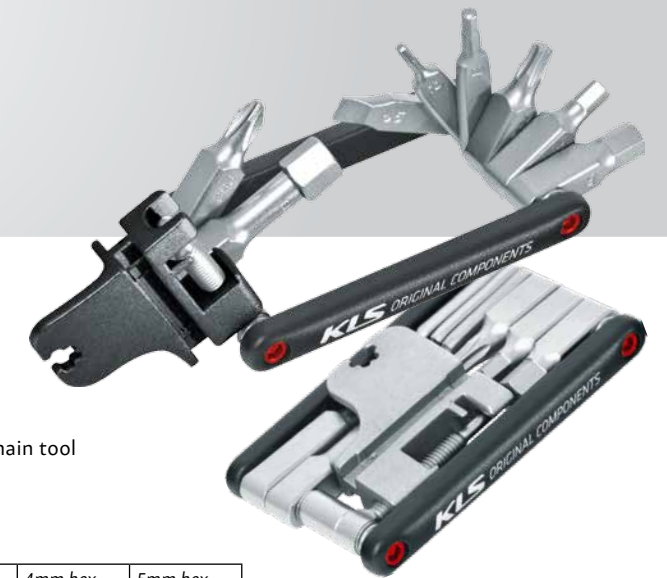

GUIDE FOLDING TOOL

Compact, lightweight (105,5g) minitool with chain tool
Hardened chromevanadium steel (CR-V) keys
15 functions, includes:

chain tool	2.5mm hex	3mm hex	4mm hex	5mm hex
6mm hex	8mm hex	T25 torx	philips head screwdriver	
flat head screwdriver	Spoke wrench 3,2 / 3,3 / 3,4 / 3,9mm			
Mavic spoke wrench				



CHAINEY FOLDING TOOL

Compact minitool with chain tool, hardened chromevanadium, steel (CR-V) hex keys
11 functions, includes:

2mm hex	2.5mm hex	3mm hex	4mm hex	5mm hex	6mm hex
8mm hex	T25 torx	philips head screwdriver	flat head screwdriver		
chain tool					





STINGER 10 FOLDING TOOL

Compact, small minitool, hardened chromevanadium steel (CR-V) hex keys
COLORS: grey, lime
10 functions, includes:

2mm hex	2.5mm hex	3mm hex	4mm hex	5mm hex	6mm hex
8mm hex	T25 torx	philips head screwdriver	flat head screwdriver		



SPARTAN 15MM PEDAL WRENCH

Ergonomic handle
Manipulation angle for better handling
Hardened chromevanadium steel (Cr-V)
15mm box wrench

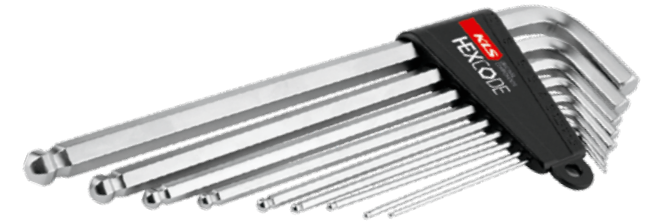

HEXCODE ALLENKEYS

Hardened chromevanadium steel (Cr-V) keys
With ball ends for up to a 30° angle of rotation
10-hex keys, includes:

1.5mm hex	2mm hex	2.5mm hex	3mm hex	4mm hex	5mm hex
6mm hex	8mm hex	10mm hex			



SPIKE CHAIN TOOL

2density ergonomic handle
Chain hook, replacable pin
For IG / HG / UG chains



TRIDENT ALLENKEYS

Plastic handle
Hardened chromevanadium steel (Cr-V) keys

4mm hex	5mm hex	6mm hex
---------	---------	---------



STINGER 8 FOLDING TOOL

Compact, small minitool, hardened chromevanadium steel (CR-V) hex keys
8 functions, includes:

2mm hex	3mm hex	4mm hex	5mm hex	6mm hex	8mm hex
philips head screwdriver		flat head screwdriver			



JACK 10 TIRE LEVERS

3 piece set of plastic levers
Large handle provides high leverage,
spoke hook



JACK 90 TIRE LEVERS

Aluminum tyre lever w/Hi-polish finish
Surrounded with the plastic protector to avoid rim from damage during use.





KLS cleaners and lubricants are premium quality and easy to use products both for riders and professional bicycle mechanics. Carefully chosen ingredients ensure easy application, high effectiveness and they are safe for the environment. Select the desired product line and keep your bike in perfect condition for years.

THE ORANGE LINE - LUBRICATION

The ORANGE line includes various lubricants, such as chain oil, universal oil or premium grease. Products from the orange line allow you to take care of every lubrication point of your bike: from chain, through cables to every bearing and axle. High-quality ingredients and modern additives reduce friction and protect the sensitive parts of a bicycle against excessive wear and corrosion.

THE BLUE LINE - CLEANING

To keep the bicycle clean and shine, and ensure smooth operation of its components, you should reach for the products from the BLUE line. Gentle but very effective cleansing ingredients thoroughly remove impurities, leaving the surface free of dirt, dust and old grease, and prepare the bicycle to put on fresh lubricants.

THE GREY LINE - CARE

Products from the GREY line give finishing touch after cleaning the bike to protect any painted and non-painted surfaces leaving deep shine and prevent dirt and wet from sticking.





SILICONE OIL

Silicone Oil is suitable for oiling and preservation during repairing and maintaining bicycles, particularly shock absorbing forks (do not confuse with oils for filling shock absorbers), O-rings, rubber seals, cables, Bowden cables, and pins in gears or lever-key switches. It may also be used for general oiling.
Spray 200ml



CHAIN OIL

As the name suggests, Chain oil is white lubricant for chains. The lubricant flows easily into the open spaces in the chain, lubricates the chain and protects it against rust. It is also suitable for O-ring chains. It doesn't contain excessive adhesive components and is, therefore, better suited for the lubrication of chains on mountain as well as highway bicycles under all types of conditions, from dust to rain.
Spray 200ml / Applicator 50ml



PREMIUM LUBE WHITE

Bike lube „white“ is a highly effective white grease with content of PTFE (polytetrafluoroethylene) useful for the lubrication of slide and roll bearings, hubs, heads, pedals, etc. The lubricant excels in its high resistance against water and provides a long life for all bearings.
Tube 100gr



MULTIFUNCTIONAL OIL BIO

Multifunctional Oil BIO is a biodegradable all-purpose fluid suitable for general lubrication, loosening of rusted joints, and prevention of corrosion.
Spray 200ml / Applicator 100ml

BIKE CLEANER

Bike Cleaner is a maintenance and cleaning agent for cleaning bicycles from mud and other contamination. Higher foaming ability ensures a lower consumption of the agent. Bike Cleaner is applied by spraying on the contaminated spots (derailleurs, pedals, hubs, frame). It is particularly suitable to clean very contaminated parts (chains, sprockets, etc.) where it adheres due to its foaming ability and thus the product consumption is lower. It does not harm paint.
Applicator 500ml/1000ml



BIKE POLISH

Bike polish is cleaner / degreaser. By simply spraying on the agent it quickly removes grease, oil, dirt and brake fluid. It is suitable for degreasing chains before being lubricated by Chain oil and also degreasing bearings, brake and clutch pads and other metal components.
Spray 200ml



MULTI DEGREASER

„Multi“ degreaser is cleaner / degreaser in one. By simply spraying on the agent it quickly removes grease, oil, dirt and brake fluid. It is suitable for degreasing chains before being lubricated by Chain oil and also degreasing bearings, brake and clutch pads, and other metal components.
Spray 750ml





KLS CONTROLSTOP V-01 CARTRIDGE

PSC - power/safe/control technology – shorter braking distance
all-weather compound
- dry conditions (red compound)
- wet conditions (grey compound)
antisqueal design
excellent rim cleaning profile
length 72mm



KLS CONTROLSTOP VR-01

replacement brake shoes for KLS CONTROLSTOP V-01



KLS CONTROLSTOP V-02

PSC - power/safe/control technology – shorter braking distance
all-weather compound
- dry conditions (red compound)
- wet conditions (grey compound)
antisqueal design
excellent rim cleaning profile
length 72mm



KLS DUALSTOP V-01 CARTRIDGE

all-weather compound
- dry conditions (red compound)
- wet conditions (black compound)
antisqueal design
excellent rim cleaning profile
length 72mm



KLS DUALSTOP VR-01

replacement brake shoes for KLS DUALSTOP V-01



KLS DUALSTOP V-02

all-weather compound
- dry conditions (red compound)
- wet conditions (black compound)
antisqueal design
excellent rim cleaning profile
length 72mm



KLS POWERSTOP V-01 CARTRIDGE

all conditions medium compound
antisqueal design
length 72mm

KLS POWERSTOP VR-01

replacement brake shoes for KLS POWERSTOP V-01



KLS POWERSTOP V-02

all conditions medium compound
antisqueal design
length 72mm

KLS POWERSTOP C-02

cantilever
all conditions medium compound
antisqueal design
length 72mm

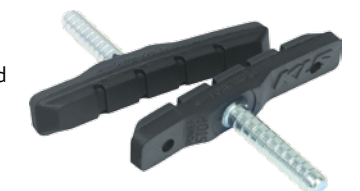



KLS D-01
ORGANIC COMPOUND

Compatible: Avid Elixir 1 / 3 / 5 / 7 / 9.R / CR / CR MAG / SRAM XO / XX Avid DB5 / DB3



KLS D-02
ORGANIC COMPOUND

Compatible: Avid Juicy 3/5/7 and ball-bearing mechanical callipers



KLS D-03
ORGANIC COMPOUND

Compatible: Shimano XTR M975, M966, M965, XT M775, M765, SLX M665, LX M585, Deore M535, Saint M800, Hone M601, Tektro Dash, Tektro Parabox



KLS D-01S
SINTERED COMPOUND

Compatible: Avid Elixir 1 / 3 / 5 / 7 / 9.R / CR / CR / MAG, Avid DB5 / DB3, SRAM XO/XX



KLS D-02S
SINTERED COMPOUND

Compatible: Avid Juicy 3/5/7 and ball-bearing mechanical callipers



KLS D-03S
SINTERED COMPOUND

Compatible: Shimano XTR M975, M966, M965, XT M775, M765, SLX M665, LX M585, Deore M535, Saint M800, Hone M601, Tektro Dash, Tektro Parabox



KLS D-04
ORGANIC COMPOUND

Compatible: Shimano Deore M515 / M475 / M355 / C501 / C601 mechanical / M615/ M506 / M525 / M415 / M465 / M475 / M485 / M495/ M447 / M395 / M355 / CX75 / C501 / C601 / M446 / M447 TEKTRO AURIGA / PRO / AQUILA, DRACO 2, DORAD, DRACO Ws, GEMINI, Promax Solve



KLS D-05
ORGANIC COMPOUND

Compatible: HAYES Stroker Trail



KLS D-06
ORGANIC COMPOUND

Compatible: HAYES Stroker Ryde



KLS D-04S
SINTERED COMPOUND

Compatible: Shimano Deore M515 / M475 / M355 / C501 / C601 mechanical / M615 / M506 / M525 / M415 / M465 / M475 / M485 / M495 / M447 / M395 / M355 / CX75 / C501 / C601 / M446 / M447, TEKTRO AURIGA / PRO / AQUILA, DRACO 2, DORAD, DRACO Ws, GEMINI, Promax Solve

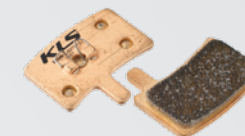

KLS D-05S
SINTERED COMPOUND

Compatible: HAYES Stroker Trail



KLS D-07
ORGANIC COMPOUND

Compatible: HAYES Prime



KLS D-08
ORGANIC COMPOUND

Compatible: Hayes So1e /MX1/MX2



KLS D-09
ORGANIC COMPOUND

Compatible: Formula Oro callipers



KLS D-06S
SINTERED COMPOUND

Compatible: HAYES Stroker Ryde



KLS D-07S
SINTERED COMPOUND

Compatible: HAYES Prime



KLS D-08S
SINTERED COMPOUND

Compatible: Hayes So1e /MX1/MX2



KLS D-10
ORGANIC COMPOUND

Compatible: Formula Oro Mega / ONE / THE ONE / R0 / R1 / RX / C1 / CR1 / CR3



KLS D-11
ORGANIC COMPOUND

Compatible: Magura Julie callipers



KLS D-12
ORGANIC COMPOUND

Compatible: Magura Clara 2001-2 /Louise 2002/ Louise FR callipers



KLS D-09S
SINTERED COMPOUND

Compatible: Formula Oro callipers



KLS D-10S
SINTERED COMPOUND

Compatible: Formula Oro Mega / ONE / THE ONE / R0 / R1 / RX / C1 / CR1 / CR3



KLS D-11S
SINTERED COMPOUND

Compatible: Magura Julie callipers



KLS D-13
ORGANIC COMPOUND

Compatible: Alhonga SNG Mechanical / 200 Disc Brake 200M / Apse Artek Mechanical disc



KLS D-14
ORGANIC COMPOUND

Compatible: Shimano XTR (15), M9020, SLX M675, XTR M985, XT M785, SLX M675, SLX M666, Deore M615, FSA K-Force DB-XC-9000, FSA Afterburner DB-XC-9150



KLS D-15
ORGANIC COMPOUND

Compatible: Avid BB5, APSE - mechanical



KLS D-12S
SINTERED COMPOUND

Compatible: Magura Clara 2001-2 / Louise 2002 / Louise FR callipers

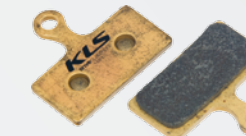

KLS D-14S
SINTERED COMPOUND

Compatible: Shimano XTR (15), M9020, SLX M675, Shimano XTR M985, XT M785, SLX M675, SLX M666, Deore M615, FSA K-Force DB-XC-9000, FSA Afterburner DB-XC-9150





TUBE REPAIR KIT

show box consist of 50 plastic boxes
plastic box consist of:
5ml of glue, 2pcs of 20mm round patches, 2pcs of 25mm round patches,
2pcs of 24x35mm rectangle patches, 1pc of sand paper, instruction manual



TUBE REPAIR KIT WITH ADHESIVE ROUND PATCHES

Show box consist of 50 plastic boxes
6PCS of self-adhesive patches in plastic box
Sandpaper for tube preparation included
Patch diameter 25mm



TUBE REPAIR KIT WITH SQUARE ADHESIVE PATCHES

Show box consist of 50 paper boxes
6PCS of self-adhesive patches in paper box
Sandpaper for tube preparation included
Patch dimension 30x30mm



KLS INNER TUBES

high quality butyl inner tubes
air pressure long-term stability
excellent resistance against puncture

WHEEL SIZE	ETRTO	INCHES	AV35	AV40	AV40 FT	AV48	AV40 45°	DV40	FV33	FV39	FV48
12 1/2"	57-203	12-1/2x2-1/4		•			•				
16"	47/57 - 305	16 x 1,75-2,0		•							
20"	47/57 - 406	20 x 1,75-2,125		•				•			
24"	47/57 - 507	24 x 1,75-2,125		•				•			
24"	37-540	24x1-3/8		•							
26"	32-559	26x1,25		•							
26"	47/57-559	26x1,75-2,125	•		•	•		•	•		•
26"	37-590	26x1-3/8						•			
27,5"	47/57-584	27,5x1,75-2,125		•	•					•	
27,5"	56/60-584	27,5x2,10-2,40									•
28"	18/23-622	700x19-23C	•			•		•	•		•
28"	25/32-622/630	700x25-32C	•			•		•	•		•
28"	35/44-622/630	700x35-43C	•			•		•	•		•
28"	47-622	700x47C			•						•
29"	47/57-622	29x1,75-2,125		•	•					•	
29"	58/62-622	29x2,20-2,50									•



TIRES

NAME	ETRTO	INCHES	TPI	DEDICATED FOR				COLOR		PROTECTION TECHNOLOGY		
				MTB-CROSS COUNTRY	CROSS/TREKING	ROAD	TIRE	BLACK	BLACK/REFLEX	CAP GUARD	LIGHT GUARD	KEVLAR INSIDE
HORIZON	23-622	700X23C	33			•		•				
RADIUS	40-622	700x38C	22		•			•				
	47-622	700x45C	22		•			•				
ELEVATION	47-305	16x1,75	22				•	•				
	54-406	20x1,95	22				•	•				
	47-507	24x1,75	22				•	•				
	47-559	26x1.75	22				•	•				
	47-559	26x1.75	22				•	•	•			
	50-584	27,5x2.0	22				•	•				
	40-622	700x38c	22				•	•				
	40-622	700x38c	22				•	•	•			
ATTACK	54-559	26x2.10	30	•				•				
	54-584	27,5x2.10	22	•				•				
	54-584	27,5x2.10	30	•				•				
	54-622	29x2.10	22	•				•				
	54-622	29x2.10	30	•				•				
SUBURBAN	54-559	26x2.0	22	•				•				
SNAKE	56-559	26x2.1	22	•				•				
CROSTOWN	37-540	24x1 3/8	22				•	•				
	37-540	24x1 3/8	22				•	•	•			
	37-590	26x1 3/8	22				•	•				
	37-590	26x1 3/8	22				•	•	•			
HORNET	54-406	20x2.0	22				•	•				
	54-507	24x2.0	22				•	•				
PARALAX	47-406	20x2.0	22				•	•				
COUGAR	47-305	16x1.75	22				•	•				
STRIKER	57-203	12 1/2x2 1/4	22				•	•				

TIRES WITH PP PROTECTION

NAME	ETRTO	INCHES	TPI	DEDICATED FOR				COLOR		PROTECTION TECHNOLOGY		
				MTB-CROSS COUNTRY	CROSS/TREKING	ROAD	TIRE	BLACK	BLACK/REFLEX	CAP GUARD	LIGHT GUARD	KEVLAR INSIDE
HORIZON	23-622	700X23C	33			•		•		•		
RADIUS	47-622	700x45C	22		•			•		•		
ELEVATION	42-622	700x40C	22				•	•			•	
ATTACK	54-584	27,5x2,1	22	•				•				•
	54-622	29x2,1	22	•				•				•
METROPOLIS	47-559	26x1,75	22				•	•		•		
WASP	47-622	700x45C	22	•				•				•



KMC CHAINS

NAME	SPEED	Color	Spec & Info	DEDICATED FOR		
				MTB	Road	Fitness/Single speed BMX, Freestyle, Fixie
KMC-X11	11	silver/gray	1/2"x11/128"	•	•	
KMC-X11EL	11	silver/gray	1/2"x11/128"	•	•	
KMC-X10 EL	10	gold or silver/silver	1/2"x11/128"	•	•	
KMC-X9	9	gray/gray	1/2"x11/128"	•	•	
KMC-X9	9	silver/gray	1/2"x11/128"	•	•	
KMC-Z7	8	gray/brown	1/2"x3/32"	•	•	
KMC-Z51	7	brown/brown	1/2"x3/32"	•	•	
KMC-Z33	6	Brown/gray	1/2"x3/32"	•	•	
KMC-Z410	1	brown/brown	1/2"x1/8"			•
KMC-Z510	1	brown/brown	1/2"x1/8"			•
CL555	11	nickel plated - silver	-	•	•	
CL559R	10	nickel plated - silver	Reusable	•	•	
CL559	10	nickel plated - silver	-	•	•	
CL559C	10	nickel plated - silver	For Campagnolo only			•
CL566R	9	nickel plated - silver	Reusable	•	•	
CL571R	7/8	nickel plated - silver	Reusable	•	•	
CL573R	7/8	nickel plated - BLUE	Reusable	•	•	





CONTACTS

AUSTRIA

KELLYS BICYCLES s.r.o.
SLNECNA CESTA 374
922 01 VELKE ORVISTE
tel.: +421 333 213 140
fax: +421 333 213 199
e-mail: vladimir.skarka@kellysbike.com

BELARUS

VELOOLIMP
MOSCOW, UL. ELEKTRODNAYA, DOM 2
tel./fax: +8 (495) 788 19 52
e-mail: mail@veloolimp.ru
www.kellys-russia.ru

BOSNIA AND HERZEGOVINA

BOCA D.O.O.
NOVACI bb PC-96
72250 VITEZ
tel./fax: +387 30 710 820
e-mail: info@bocavitez.com

CHINA

YONG QI (CHANGZHOU) BICYCLE
INOUSTRIAL CO., LTD.
No.689, TONG JIANG ZHONG RD, NEW DISTRICT,
CHANG ZHOU CITY, JIANGSU PROVINCE, CHINA
TEL: +519-69883888
FAX:+519-69882168
e-mail: kellysbike@yong-qi.com

CROATIA

L. K. D. D.O.O. KUTINA
A.G. MATOSA 12
KUTINA
tel. / fax: +385 (0)44 683 504
e-mail: mbjelajac@inet.hr
www.bikeshop.hr

CYPRUS

TASOS ALETRAS Ltd.
266 TSERIOU AVENUE
2044 NICOSIA STROVOLOS
tel.: +35 722 321015
fax: +35 722 321731
e-mail: info@aletras-megabike.com
www.aletras-megabike.com

CZECH REPUBLIC

KELLYS BICYCLES CZECH REPUBLIC s.r.o.
HAVLÍČKOVA 426
753 01 HRANICE
tel.: +420 581 698 810
e-mail: infocz@kellysbike.com

ESTONIA

VELOPLUS
SAKU 3
11314 TALLINN
tel.: +372 6 556 977
fax: +372 6 556 308
e-mail: veloplus@veloplus.ee
www.veloplus.ee

FRANCE

FREE SPORT SPIRIT
33 rue Brechenmacher
68380, Breitenbach
Tel.: +33 695 853 578
e-mai:contact-kellysbike@orange.fr

GERMANY

KELLYS BICYCLES DEUTSCHLAND
AM WALDBERG 15
12683 BERLIN
tel.: +49 (0)30 510 61 837
fax: +49 (0)30 510 61 838
e-mail: kellysdeutschland@kellysbike.com

GREECE

M BIKES SPORTS ON WHEELS
THESSALONIKI, P.SYNDIKA 59
tel.: +30 2310 886 545
fax: +30 2310 886 546
e-mail: mbikes@mbikes.gr
www.mbikes.gr

HUNGARY

KELLYS BICYCLES s.r.o.
1051 Budapest,
Arany Janos u. 15.
tel: +36 20 351 7141
e-mail: Infohug@kellysbike.com

ITALY

MODOLO ITALIA SRLS
VIA B. CROCE 62
31015 CONEGLIANO v. TO
ITALY
tel.: +39 348 653 8599
tel.: +39 348 778 2801
e-mail: serena@modolo.com
e-mail: pietro.caschera@gmail.com

IRELAND

A.B. CYCLE FACTORS Ltd.
14A SOUTH SUMMER STREET
DUBLIN 8
tel.: +353 1 4532777
fax: +353 1 4544793
email: abcycles@eircom.net

KAZAKHSTAN

TOO Amber LOOK
Dosmukhamedov 68B Biuro 11
Almaty
Tel.: +7 727 220 6763
e-mail: info@mybike.kz

LATVIA

SIA AQUA PRO
GAROZES 1
LV-1004 RIGA
tel.: +371 762 6025
fax: +371 789 2053
e-mail: jurism@fans.lv

LITHUANIA

UAB MyBike
Draugystes 17
LT-51229, Kaunas
tel./fax: +370 3735 00 95
e-mail: aistis@mybike.lt

NORWAY

TEMPO AS
TORVLIA 14
1739 BORGENHAUGEN
tel: +47 69 100 570
fax: +47 69 166 252
e-mail: john@tempoas.no
www.tempoas.no

POLAND

KELLYS Sp. z.o.o.
UL. E. KWIATKOWSKIEGO 24
55-011 SIECHNICE K. WROCŁAWIA
tel.: +48 71 318 88 77
fax: +48 71 318 88 99
e-mail: infopl@kellysbike.com

PORTUGAL

ALEXANDRE DIAS LDa
AV. VILLAGARCIA DE AROSA, 1060
4450-300 MATOSINHOS
tel.: +351 229 398 990
fax: +351 229 398 993
e-mail: alex.dias@mail.telepac.pt
www.alexandredias.net

RUSSIA

VELOOLIMP
MOSCOW, UL. ELEKTRODNAYA, DOM 2
tel./fax: +7 (495) 788 19 52
e-mail: mail@veloolimp.ru
www.kellys-russia.ru

SERBIA

NEOBIKE D.O.O.
TOLSTOJEVA 14
210 00 NOVI SAD
tel.: +381 21 542 216
fax: +381 21 542 217
e-mail: neobike@ptt.yu
www.neobike.co.yu

SLOVAKIA

KELLYS BICYCLES s.r.o.
SLNECNÁ CESTA 374
922 01 VELKÉ ORVIŠTE
tel.: +421 333 213 111
fax: +421 333 213 199
e-mail: infosk@kellysbike.com

SWEDEN

JAMTLANDS CYKELFABRIK
KYRGATAN 27
S-83131 ÖSTERSUND
tel./fax: +46 63 12 72 22
e-mail: info@jamtlandscykelfabrik.se

TAIWAN

UNI-VICTOR INT'L CORP.
NO. 1, RENHUAGONG 10th RD., DALI DIST.,
TAICHUNG 41278
TAIWAN
tel.: +886 4 249 16 008
fax: +886 4 249 16 007
e-mail: infotw@kellysbike.com

THAILAND

THE ASCENT (THAILAND) CO., LTD
NO. 317 MOO 4 SOI 6C,
BANGPOO INDUSTRIAL ESTATE,
SUKHUMVIT ROAD, PRAEKKASA,
MUANG-SAMUTPRAKARN,
SAMUTPRAKARN, THAILAND 10280
Tel.: +66 2709 6580 EXT.175
Fax: +66 2709 6589
e-mail: info@ascent-thailand.com
www.ascent-thailand.com

UKRAINE

Veloportal LLC
6-A, HETMANA STR.
03057 KIEV
tel./fax: +380 44 331 9050
e-mail: admin@kellys.com.ua
www.kellys.com.ua

JOIN US ON SOCIAL NETWORKS



[INSTAGRAM.COM/KELLYSBIKES](https://www.instagram.com/kellysbikes)



[FACEBOOK.COM/KELLYSBICYCLES](https://www.facebook.com/kellysbicycles)



[YOUTUBE.COM/USER/KELLYSBICYCLES](https://www.youtube.com/user/kellysbicycles)

VISIT OUR WEBSITE



[KELLYSBIKE.COM](https://www.kellysbike.com)



KELLYSBIKE.COM
kellys@kellysbike.com

**ACCESSORIES
CATALOGUE**
SEASON
2017



**EVERY BIKE
HAS A MISSION**